

catálogo 2018

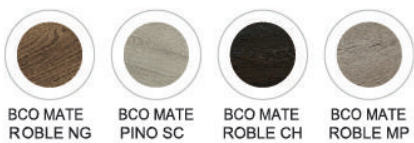

TIME

ROBLE NG



CAJON METALICO EXTRACCION TOTAL



CONJUNTO COMPUESTO POR:
 ESPEJO LISO 80X80
 ENCIMERA CERÁMICA 81cm H-19 F-46
 MUEBLE TIME 110

CONJUNTO COMPUESTO POR:
 ESPEJO LISO 100X80
 ENCIMERA CERÁMICA 101cm H-19 F-46
 MUEBLE TIME 130

AUXILIAR30X100X25,5 185€

110cm
555€

130cm
650€



AVANTI

ROBLE
NG

IZQ

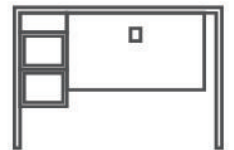

DRCH

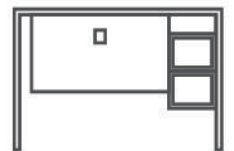

Tablero de Partículas
Superpan Melamina
Maderas



ROBLE MP



PINO SC



ROBLE NG

CONJUNTO COMPUESTO POR:
ESPEJO LISO 100X80
LAVABO K40
MUEBLE AVANTI 100 FONDO 50
BASTIDOR METÁLICO COLOR GRAFITO

CAJON METALICO EXTRACCION TOTAL



570€



LATTO

CONJUNTO	COLOR	SIN ESPEJO
80x60x45	530 €	-38 €
100x60x45	642 €	-43 €
120x60x45	755 €	-49 €
AUXILIAR 40x100x25,5		173 €

CONJUNTO COMPUESTO POR:

- ESPEJO LISO.
- ENCIMERA CERAMICA H-19 IZQ F-46
- MUEBLE 2 CAJONES 2 HUECOS
- CAJONES METÁLICOS EXTRACCIÓN TOTAL



moka bco mate gris mate bco mate roble mp bco mate roble ch bco mate pino sc bco mate roble ng bco mate



TRENDY 120cm



TRENDY 60/80/100cm

CONJUNTO	PVP	SIN ESPEJO
60x80x45	321 €	-35 €
80x80x45	368 €	-38 €
100x80x45	438 €	-43 €
120x80x45	580 €	-49 €

- CONJUNTO COMPUESTO POR:
- ESPEJO LISO.
 - ENCIMERA CERAMICA H-19 F-46
 - MUEBLE
 - CAJONES METÁLICOS EXTRACCIÓN TOTTAL
 - OPCIÓN PARA MUEBLE: LUZ CON SENSOR 25€





STREET P



STREETS



CONJUNTO	PVP	SIN ESPEJO
60x80x45 P	418 €	-33 €
80x80x45 P	461 €	-38 €
100x80x45 P	525 €	-43 €
60x50x45 S	335 €	-33 €
80x50x45 S	368 €	-38 €
100x80x45 S	430 €	-43 €
COLUMNA 34x136x34 2P	165 €	

CONJUNTO COMPUESTO POR:

- ESPEJO LISO.
- ENCIMERA CERAMICA H-19
- MUEBLE
- CAJONES METÁLICOS EXTRACCIÓN TOTAL

P= MUEBLE 3 CAJONES A SUELO
S= MUEBLE 2 CAJONES SUSPENDIDO



TODAY P3G



TODAY S2G

CONJUNTO	PVP	SIN ESPEJO
80x46x45 S2G	345 €	-38 €
100x46x45 S2G	409 €	-43 €
80x80x45 P3G	390 €	-38 €
100x80x45 P3G	455 €	-43 €
COLUMNA 34x136x34 2P	152 €	
ALTO COLGAR 60x73x25	122 €	

CONJUNTO COMPUESTO POR:

- ESPEJO LISO.
- ENCIMERA CERAMICA H-19
- MUEBLE
- CAJONES METÁLICOS EXTRACCIÓN TOTAL

S2G= 2 CAJONES + 1 PUERTA SUSPENDIDO
P3G= 3 CAJONES + 1 PUERTA A SUELO

SERIE LEMAN

BAJO PORTALAVABO
Con cajón extracción total

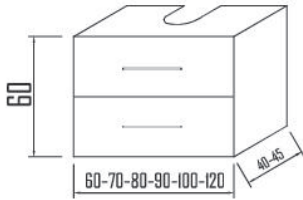

BAJO PORTALAVABO	MDF DISEÑO BLANCO	TODO COLOR
60x60x45	349€	401 €
70x60x45	358€	412 €
80x60x45	363€	417 €
90x60x45	374€	430 €
100x60x45	384€	442 €
120x60x45*	405€	466 €

*(1 UNIDAD)

BAJO PORTALAVABO
Con cajón extracción total

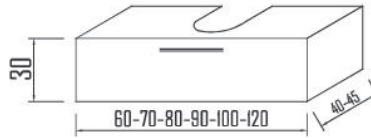

BAJO PORTALAVABO	MDF DISEÑO BLANCO	TODO COLOR
60x30x45	250€	288 €
70x30x45	258€	297 €
80x30x45	265€	305 €
90x30x45	270€	311 €
100x30x45	276€	317 €
120x30x45*	287€	330 €

*(1 UNIDAD)

MÓDULO CAJÓN CON TAPA
Con cajón extracción total

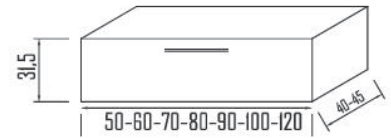

MÓDULO CAJÓN	MDF DISEÑO BLANCO	TODO COLOR
50x31,5x45	275 €	316 €
60x31,5x45	275 €	316 €
70x31,5x45	283 €	325 €
80x31,5x45	291 €	335 €
90x31,5x45	297 €	342 €
100x31,5x45	303 €	348 €
120x31,5x45*	320 €	368 €

*(1 UNIDAD)

(*) EXTRACCIÓN TOTAL GUIA METÁLICA HETTICH

EL RESTO DE MEDIDAS CON GUARDERA DE MADERA CON GUIA HETTICH | SE FABRICAN EN FONDO 45 Y 39 SIN INCREMENTO DE PRECIO

SERIE PANAMA

BAJO PORTALAVABO
Con cajón extracción total

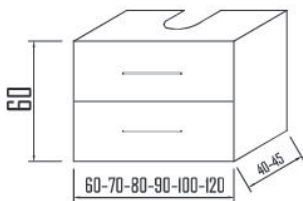

BAJO PORTALAVABO	MDF DISEÑO BLANCO	TODO COLOR
60x60x45	367 €	422 €
70x60x45	373 €	429 €
80x60x45	380 €	437 €
90x60x45	387 €	445 €
100x60x45	398 €	457 €
120x60x45*	416 €	478 €

*(1 UNIDAD)

BAJO PORTALAVABO
Con cajón extracción total

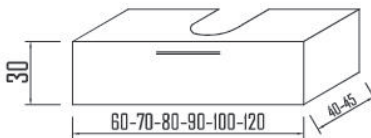

BAJO PORTALAVABO	MDF DISEÑO BLANCO	TODO COLOR
60x30x45	271 €	312 €
70x30x45	276 €	317 €
80x30x45	282 €	325 €
90x30x45	289 €	332 €
100x30x45	298 €	342 €
120x30x45*	313 €	360 €

*(1 UNIDAD)

MÓDULO CAJÓN CON TAPA
Con cajón extracción total

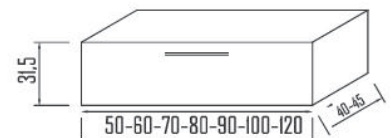

MÓDULO CAJÓN	BLANCO	TODO COLOR
50x31,5x45	291 €	336 €
60x31,5x45	296 €	341 €
70x31,5x45	301 €	346 €
80x31,5x45	308 €	354 €
90x31,5x45	316 €	363 €
100x31,5x45	325 €	374 €
120x31,5x45*	346 €	398 €

*(1 UNIDAD)

BASTIDOR SIN TAPA
PARA ENCIMERA CERAMICA

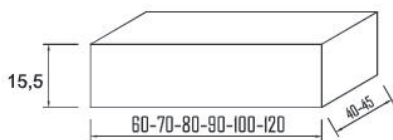

MEDIDAS	BLANCO	COLOR	INCR. TAPA
61	195€	224€	62€
71	199€	228€	73€
81	205€	235€	83€
91	210€	241€	94€
101	215€	247€	104€
121	220€	253€	125€

ENCIMERAS Y LAVABOS VER EN PÁG.34-35-36

ESPEJOS VER EN PÁG. 32

ILUMINACION VER EN PÁG. 33

JUEGO DE PATAS 13€ (4 UNIDADES)

VER COLORES PÁG. 21

LEMAN

PANAMA

MEDIDAS	MDF DISEÑO BLANCO	COLOR	BLANCO	COLOR
30x30x20 A	95€	109€	95€	109€
30x30x20	126€	144€	140€	161€
30x60x20	161€	185€	190€	218€
30x60x20	178€	205€	194€	223€
30x90x20	190€	218€	264€	304€
30x120x20	246€	283€	317€	365€
35x177x30	301€	346€	358€	411€

MEDIDAS ESPECIALES CONSULTAR

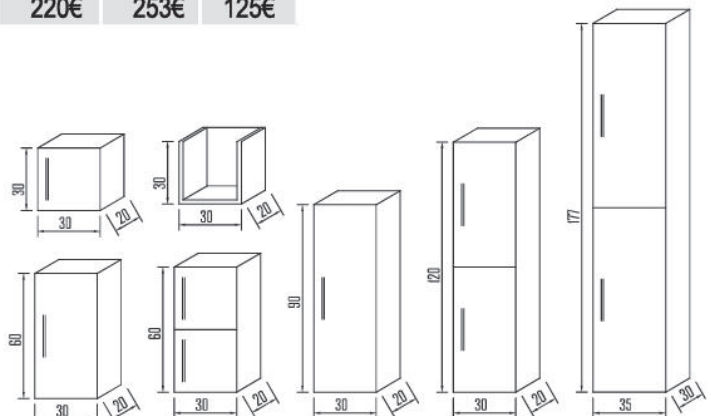

Puertas con cierre amortiguado

SERIE **LEMAN**



PANAMA



Cajones metálicos extracción total





MODELO **DALLAS**

CONJUNTO	BLANCO O LAMINADO	COLOR	SIN ESPEJO
60x60x45	391 €	515 €	-33 €
70x60x45	412 €	547 €	-35 €
80x60x45	426 €	565 €	-38 €
90x60x45	484 €	671 €	-38 €
100x60x45	494 €	681 €	-43 €

CONJUNTO COMPUESTO POR:

ESPEJO LISO.

ENCIMERA CERAMICA FONDO 46/40 H-19.

MUEBLE 2CAJONES 1 PUERTA, FONDO 39/45.

CAJONES DE MADERA CON GUIA HETTICH.

INCREMENTO CAJONES METALICOS HETTICH 50€.

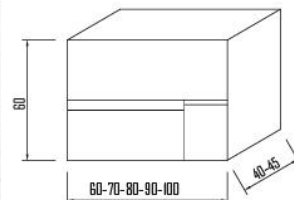

AUXILIARES PÁG. 5 SERIE LEMAN.

VER COLORES PÁG. 21.



MODELO **ARIZONA**

CONJUNTO	BLANCO O LAMINADO	COLOR	SIN ESPEJO
60x60x45	473 €	525 €	-33 €
70x60x45	493 €	547 €	-35 €
80x60x45	502 €	556 €	-38 €
90x60x45	561 €	617 €	-38 €
100x60x45	571 €	629 €	-43 €
120x60x46	655 €	716 €	-49 €

CONJUNTO COMPUESTO POR:

ESPEJO LISO.

ENCIMERA CERAMICA H-19 F-40/46.

MUEBLE 2 CAJONES, FONDO 39/45.

CAJONES DE MADERA CON GUIA HETTICH

CAJONES METALICOS HETTICH

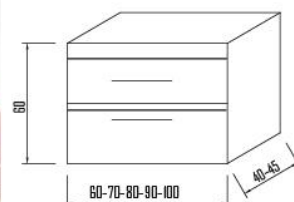

VER AUXILIARES EN PÁG. 5 SERIE PANAMA.

VER COLORES PÁG. 21.



MODELO
SINGAPUR

CONJUNTO COMPUESTO POR:
 ESPEJO LISO
 ENCIMERA CARGA MINERAL
 LAVABO DE CARGA MINERAL
 MUEBLE 2 CAJONES, FONDO 45.
 CAJONES METÁLICOS HETTICH.
 VER COLORES PÁG. 21



CONJUNTO	BLANCO	TODO COLOR
80x55x45	967 €	1.036 €
100x55x45	1.028 €	1.099 €

MEDIDAS	BLANCO	TODO COLOR
30x30x20 A	95 €	109 €
30x30x20 1P	152 €	175 €
30x60x20 1P	171 €	197 €
30x90x20 1P	212 €	244 €
30x90x20 2P	220 €	253 €
35x120x30 2P	271 €	312 €

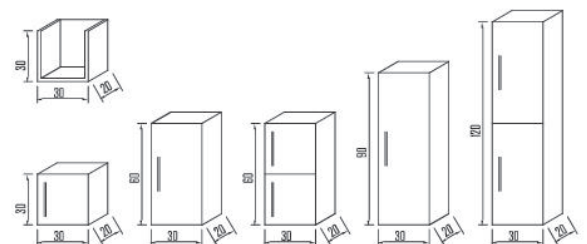



MODELO **NATURA**

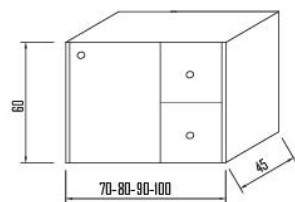

CONJUNTO	MDF	SIN ESPEJO
70x60x45	480 €	-35 €
80x60x45	494 €	-38 €
90x60x45	512 €	-38 €
100x60x45	524 €	-43 €

CONJUNTO COMPUESTO POR:

ESPEJO LISO.

LAVABO CERAMICO OVALO 60,5x40x14,5.

MUEBLE 2 CAJONES +1 PUERTA CORREDERA.
FONDO 45.

CAJONES METALICOS CON GUIA HETTICH.



MODELO **NEXT**

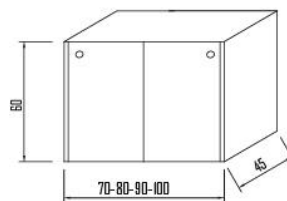

CONJUNTO	MDF	SIN ESPEJO
70x60x45	367 €	-35 €
80x60x45	385 €	-38 €
90x60x45	397 €	-38 €
100x60x45	419 €	-43 €

CONJUNTO COMPUESTO POR:

ESPEJO LISO.

LAVABO CERAMICO OVALO 60,5x40x14,5.

MUEBLE 2 PUERTA CORREDERA.
GUIA HETTICH.

FONDO 45.

Maderas



Castaño



Nebraska

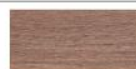

Siroco



Roble Olmo



Pino Blanco



CONJUNTO	BLANCO	COLOR	SIN ESPEJO	AUXILIARES	BLANCO	COLOR
60x60x45	434 €	496 €	-33 €	35x90x20	227 €	255 €
70x60x45	480 €	549 €	-35 €	35x120x20	269 €	309 €
80x60x45	487 €	556 €	-38 €	35x177x30	345 €	392 €
90x60x45	535 €	612 €	-38 €			
100x60x45	549 €	626 €	-43 €			

Puertas con cierre amortiguado

CONJUNTO COMPUESTO POR:

- ESPEJO LISO.
- ENCIMERA CERAMICA H-19.
- MUEBLE 2 CAJONES, FONDO 39/45.
- CAJONES DE MADERA CON GUIA HETTICH
- INCREMENTO CAJONES METALICOS HETTICH 50€
- VER COLORES PÁG. 21

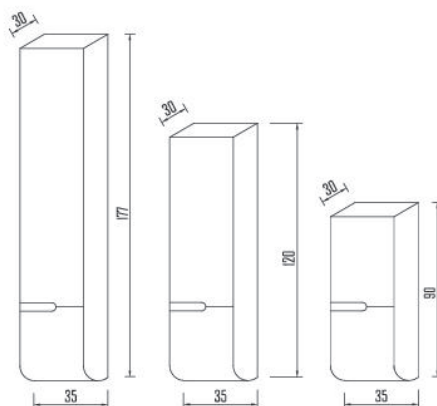
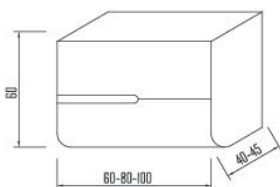



MODELO **AURORA**

CONJUNTO	BLANCO O LAMINADO	COLOR	SIN ESPEJO
60x82x45	453 €	500 €	-33 €
70x82x45	470 €	518 €	-35 €
80x82x45	489 €	539 €	-38 €
90x82x45	552 €	605 €	-38 €
100x82x45	576 €	630 €	-49 €

CONJUNTO COMPUESTO POR:

ESPEJO LISO.

ENCIMERA CERAMICA H-19.

MUEBLE 3CAJONES, FONDO 39/45.

CAJONES DE MADERA CON GUIA HETTICH

INCREMENTO CAJONES METALICOS HETTICH 75€

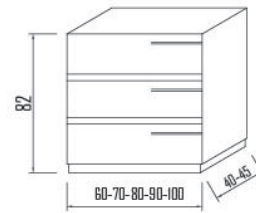

ZOCALO O PATAS MISMO PRECIO.
VER COLORES PÁG. 21.

SAMARA

CONJUNTO COMPUESTO POR:

ESPEJO LISO.

ENCIMERA CERAMICA FONDO 46.

MUEBLE 2CAJONES, FONDO 39/45.

CAJONES DE MADERA CON GUIA HETTICH.

INCREMENTO CAJONES METALICOS HETTICH 50€.

VER COLORES PÁG. 21.

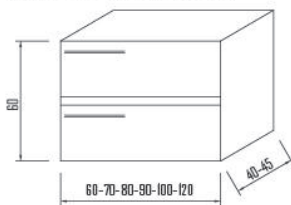

CONJUNTO	BLANCO O LAMINADO	COLOR	SIN ESPEJO
60x60x45	411 €	452 €	-33 €
70x60x45	430 €	472 €	-35 €
80x60x45	452 €	496 €	-38 €
90x60x45	520 €	567 €	-38 €
100x60x45	545 €	594 €	-49 €



AUXILIARES	BLANCO O LAMINADO	COLOR
30x30x20	95 €	109 €
30x30x20(1 puerta)	126 €	144 €
30x60x20(1 puerta)	161 €	185 €
30x60x20(2 puertas)	178 €	205 €
30x90x20(1 puerta)	190 €	218 €
30x120x20(2 puertas)	246 €	283 €
35x177x30(2 puertas)	301 €	346 €

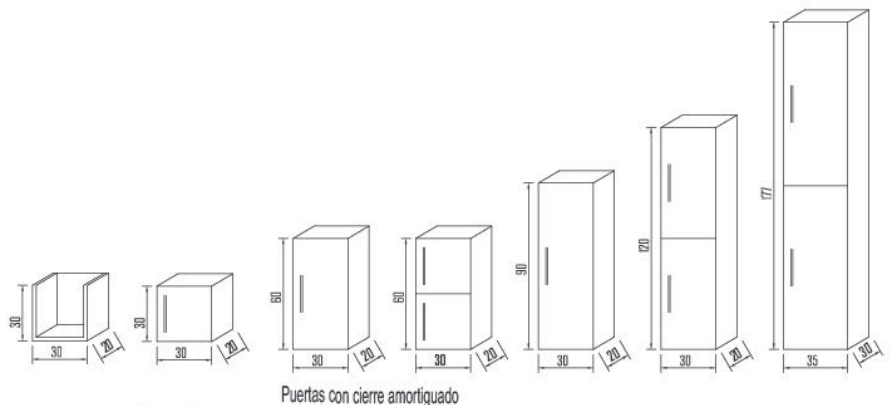



MODELO **KONVO**

CONJUNTO	BLANCO	COLOR	SIN ESPEJO
60x82x45	760 €	835 €	-33 €
80x82x45	835 €	905 €	-38 €
100x82x45	925 €	990 €	-43 €

CONJUNTO COMPUESTO POR:

ESPEJO LISO.

ENCIMERA CERAMICA BLANCA CURVA.

MUEBLE 3 CAJONES, FONDO 45,

COSTADOS FONDO 39.

CAJONES METALICOS HETTICH.

VER COLORES PÁG. 21

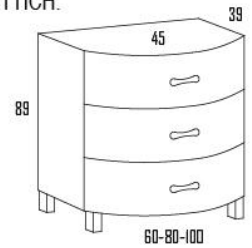

MODELO **INSIDE**

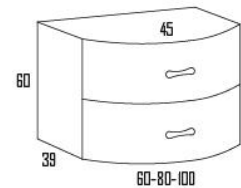

CONJUNTO	BLANCO	COLOR	SIN ESPEJO
60x60x45	625 €	690 €	-33 €
80x60x45	680 €	750 €	-38 €
100x60x45	765 €	840 €	-43 €

CONJUNTO COMPUESTO POR:

ESPEJO LISO.

ENCIMERA CERAMICA BLANCA CURVA.

MUEBLE 2CAJONES, FONDO 45,

COSTADOS FONDO 39.

CAJONES DE MADERA CON GUIA HETTICH

INCREMENTO CAJONES METALICOS HETTICH 66€

VER COLORES PÁG. 21

AUXILIARES	BLANCO	COLOR
30x30x20 A	95 €	109 €
30x30x20 1P	120 €	138 €
30x60x20 2P	167 €	195 €
30x120x20 2P	236 €	275 €
35x177x30 2P	295 €	336 €

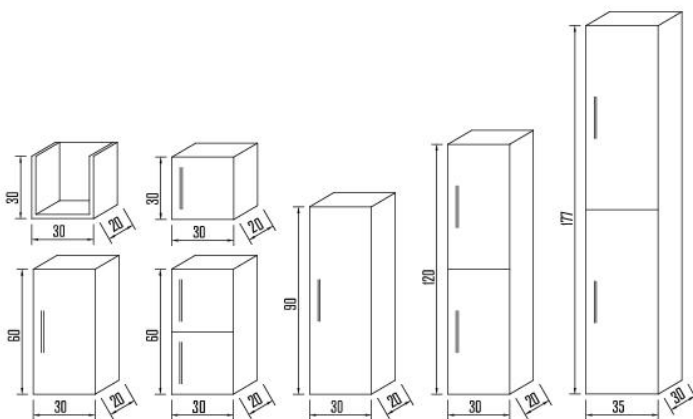

Puertas con cierre amortiguado



SERIE STEFANO -1

CONJUNTO COMPUESTO POR:
 ESPEJO LISO.
 ENCIMERA CERAMICA FONDO 46 DRCHO. O IZQ.
 MUEBLE 1 CAJÓN + HUECO.
 GUIA HETTICH EXTRACCIÓN TOTAL.

CONJUNTO	BLANCO O LAMINADO	COLOR	SIN ESPEJO
80x60x45	425 €	465 €	-38 €
90x60x45	468 €	508 €	-38 €
100x60x45	531 €	574 €	-43 €
120x60x46	632 €	677 €	-49 €

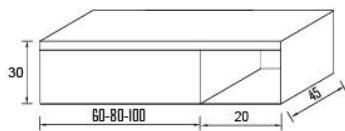

VER COLORES PÁG. 21



SERIE STEFANO -3

CONJUNTO	BLANCO O LAMINADO	COLOR	SIN ESPEJO
80X60X45	505 €	560 €	-38 €
90X60X45	548 €	607 €	-38 €
100X60X45	573 €	635 €	-43 €
120X60X46	652 €	718 €	-49 €

CONJUNTO COMPUESTO POR:
 ESPEJO LISO.
 ENCIMERA CERAMICA FONDO 46/40 CENTRADA.
 MUEBLE 3 CAJONES + 1 PUERTA.
 GUIA HETTICH EXTRACCIÓN PARCIAL.
 GUIA HETTICH EXTRACCIÓN TOTAL 75 €.

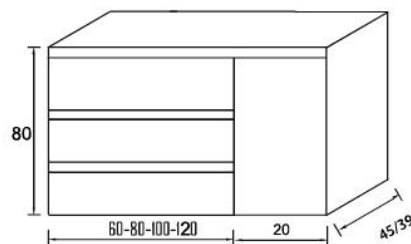

VER COLORES PÁG. 21
 ZÓCALO, PATAS O SUSPENDIDO

SERIE STEFANO-2

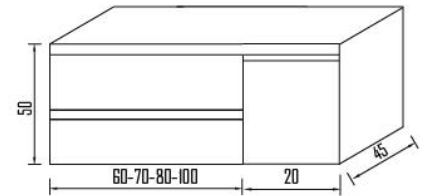

CONJUNTO COMPUESTO POR:

ESPEJO LISO.
ENCIMERA CERAMICA FONDO 46/40 CENTRADA.
MUEBLE 2 CAJONES + 1 PUERTA FONDO 39/45.
CAJONES MADERA CON GUIA HETTICH.
INCREMENTO EXTRACCIÓN TOTAL 50 €.

CONJUNTO	BLANCO O LAMINADO	COLOR	SIN ESPEJO
80x60x45	455 €	497 €	-38 €
90x60x45	492 €	545 €	-38 €
100x60x45	520 €	569 €	-43 €
120x60x46	595 €	650 €	-49 €

VER COLORES PÁG. 21

AUXILIARES	BLANCO O LAMINADO	COLOR
30x30x20	95 €	109 €
30x30x20 (1 puerta)	128 €	147 €
30x60x20 (1 puerta)	146 €	168 €
30x60x20 (2 puertas)	162 €	186 €
30x90x20 (1 puerta)	184 €	211 €
30x120x20 (2 puertas)	232 €	267 €
35x177x30 (2 puertas)	291 €	335 €

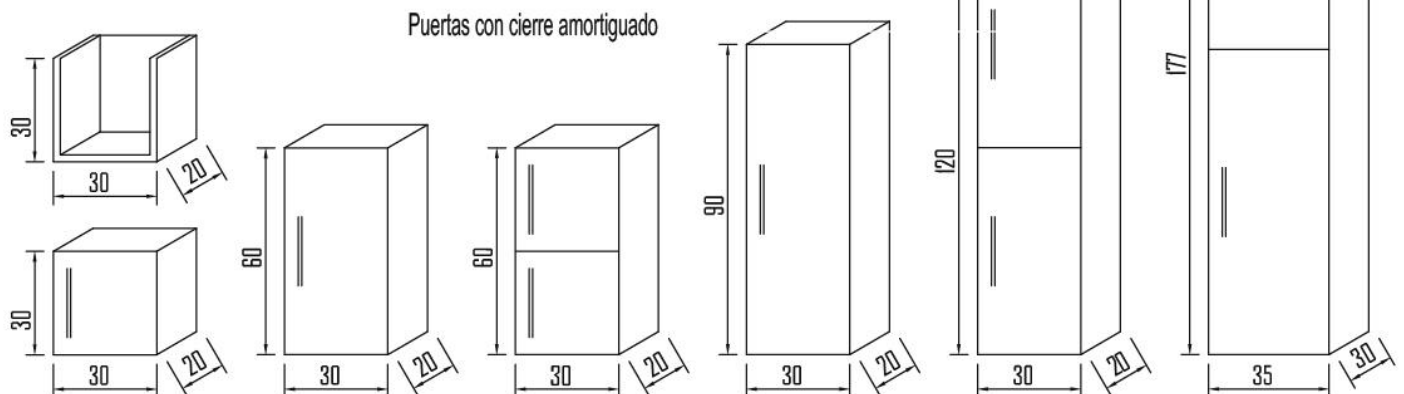



MODELO **STYLO**

CONJUNTO	BLANCO O LAMINADO	COLOR	SIN ESPEJO
80x60x45	550 €	610 €	-38 €
90x60x45	607 €	669 €	-38 €
100x60x45	616 €	683 €	-43 €
120x60x46	754 €	827 €	-49 €

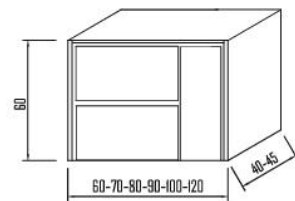

CONJUNTO COMPUESTO POR:
 ESPEJO LISO.
 ENCIMERA CERAMICA H-19 FONDO 46/40.
 MUEBLE 2 CAJONES + 1 PUERTA, FONDO 39/45.
 CAJONES METALICOS HETTICH.
 VER COLORES PÁG. 21

MODELO **MOON**

CONJUNTO	BLANCO O LAMINADO	COLOR	SIN ESPEJO
60x60x45	506 €	564 €	-33 €
70x60x45	522 €	582 €	-35 €
80x60x45	532 €	592 €	-38 €
90x60x45	558 €	647 €	-38 €
100x60x45	589 €	654 €	-43 €
120x60x46	665 €	732 €	-49 €

CONJUNTO COMPUESTO POR:
 ESPEJO LISO.
 ENCIMERA CERAMICA H-19 FONDO 46/40.
 MUEBLE 2CAJONES, FONDO 39/45.
 CAJONES DE MADERA CON GUIA HETTICH.
 INCREMENTO CAJONES METALICOS HETTICH 50€.
 VER COLORES PÁG. 21.

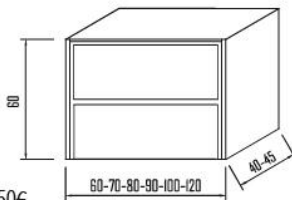

Puertas con cierre amortiguado

AUXILIARES	BLANCO O LAMINADO	COLOR
30x60x20	156 €	179 €
30x120x20	259 €	298 €

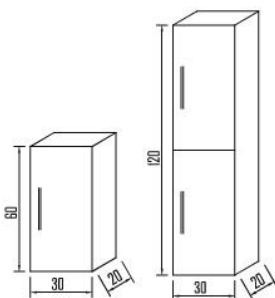



MODELO **ACUARIO**

CONJUNTO	BLANCO O LAMINADO	COLOR	SIN ESPEJO
60x60x45	386 €	426 €	-33 €
70x60x45	425 €	471 €	-35 €
80x60x45	451 €	500 €	-38 €
90x60x45	495 €	546 €	-38 €
100x60x45	520 €	574 €	-43 €

CONJUNTO COMPUESTO POR:
 ESPEJO LISO.
 ENCIMERA CERAMICA H-19 FONDO 40/46.
 MUEBLE 2 CAJONES CIERRE AMORTIGUADO.

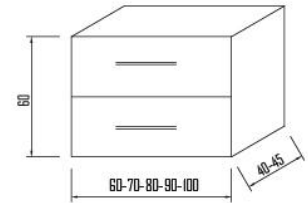

AUXILIARES VER PÁGINA 15
 COLORES VER PÁGINA 21



MODELO **BAYONA**

CONJUNTO	BLANCO O LAMINADO	COLOR	SIN ESPEJO
60x80x45	461 €	514 €	-33 €
70x80x45	491 €	545 €	-35 €
80x80x45	505 €	561 €	-38 €
90x80x45	544 €	603 €	-38 €
100x80x45	566 €	625 €	-43 €

CONJUNTO COMPUESTO POR:
 ESPEJO LISO.
 ENCIMERA CERAMICA H-19 F-40/46.
 MUEBLE 3 CAJONES CIERRE AMORTIGUADO.

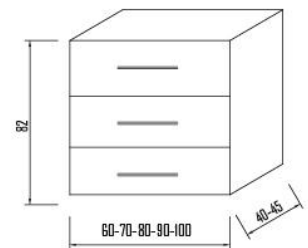

AUXILIARES VER PÁGINA 15
 COLORES VER PÁGINA 21



MODELO **TANIA**

CONJUNTO	BLANCO O LAMINADO	COLOR	SIN ESPEJO
60x60x45	388 €	430 €	-33 €
70x60x45	430 €	476 €	-35 €
80x60x45	451 €	499 €	-38 €
90x60x45	490 €	540 €	-38 €
100x60x45	521 €	574 €	-43 €
120x60x46	650 €	708 €	-49 €

CONJUNTO COMPUESTO POR:
 ESPEJO LISO.
 ENCIMERA CERAMICA H-19 F-40/46.
 MUEBLE 2 CAJONES FONDO 39/45.
 CAJONES DE MADERA CON GUIA HETTICH
 INCREMENTO CAJONES METALICOS HETTICH 50€
 (EL CONJUNTO DE 120cm CAJONES METALICOS)

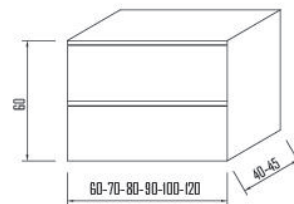

MODELO **CRES**

CONJUNTO	BLANCO O LAMINADO	COLOR	SIN ESPEJO
60x82x45	465 €	518 €	-33 €
70x82x45	490 €	546 €	-35 €
80x82x45	505 €	562 €	-38 €
90x82x45	545 €	602 €	-38 €
100x82x45	567 €	627 €	-43 €
120x82x46	689 €	752 €	-49 €

CONJUNTO COMPUESTO POR:
 ESPEJO LISO.
 ENCIMERA CERAMICA H-19 F40/46.
 MUEBLE 3 CAJONES FONDO 39/45.
 CAJONES DE MADERA CON GUIA HETTICH
 INCREMENTO CAJONES METALICOS HETTICH 75€
 (EL CONJUNTO DE 120cm CON CAJONES METALICOS)

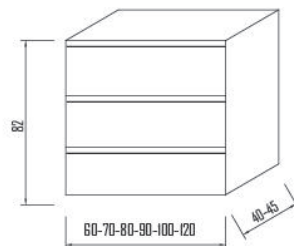

AUXILIARES VER PAGINA 15.
 COLORES VER PAGINA 21.



KORAL

CONJUNTO	BLANCO O LAMINADO	COLOR	SIN ESPEJO
80x82x45	551 €	582 €	-38 €
90x82x45	587 €	652 €	-38 €
100x82x45	605 €	671 €	-43 €
120x82x46	691 €	760 €	-49 €

CONJUNTOS COMPUESTOS POR:
ESPEJO LISO.

ENCIMERA CERAMICA H-19 F-40/46.

MUEBLE 3 CAJONES + 1 PUERTA ABATIBLE

CIERRE AMORTIGUADO HETTICH

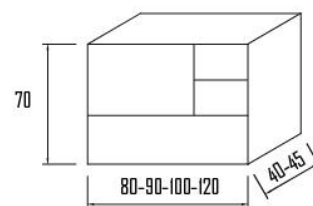

AUXILIARES VER PÁGINA 15

COLORES VER PÁGINA 21



ASIS

CONJUNTO	BLANCO O LAMINADO	COLOR	SIN ESPEJO
60x82x45	366 €	402 €	-33 €
70x82x45	407 €	450 €	-35 €
80x82x45	436 €	487 €	-38 €
90x82x45	492 €	549 €	-38 €
100x82x45	533 €	595 €	-43 €
120x82x46	690 €	762 €	-49 €

CONJUNTOS COMPUESTOS POR:

ESPEJO LISO.

ENCIMERA CERAMICA H-19 F-40/46

MUEBLE 2 CAJONES CIERRE AMORTIGUADO HETTICH

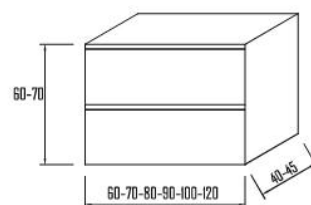



MODELO **PIANA**

CONJUNTO	BLANCO O LAMINADO	COLOR	SIN ESPEJO
60x82x45	481 €	558 €	-33 €
70x82x45	504 €	584 €	-35 €
80x82x45	515 €	597 €	-38 €
90x82x45	559 €	638 €	-38 €
100x82x45	589 €	671 €	-43 €
120x82x46	749 €	831 €	-49 €

CONJUNTOS COMPUESTOS POR:

ESPEJO LISO.

ENCIMERA CERAMICA H-19 FONDO 40/46.

MUEBLE 3 CAJONES

CAJONES DE MADERA CON GUIA HETTICH

INCREMENTO EXTRACCION TOTAL 75€



COLORES VER PÁG. 21.
AUXILIARES VER PÁG 15.



MODELO **ISABELINO**

CONJUNTO	BLANCO	COLOR	SIN ESPEJO
70X82X45	660 €	695 €	-98 €
80X82X45	687 €	728 €	-113 €
90X82X45	769 €	813 €	-128 €
100X82X45	807 €	853 €	-143 €
120X82X45	990 €	1.072 €	-159 €

CONJUNTOS COMPUESTOS POR:

ESPEJO ISABELINO.

ENCIMERA CERAMICA H-19 FONDO 40/46 .

MUEBLE FONDO 40/60.

CAJONES DE MADERA CON GUIA HETTICH

INCREMENTO EXTRACCION TOTAL 50€

COLORES VER PAGINA 21.

COLECCIÓN MINI



AURORA SAMARA

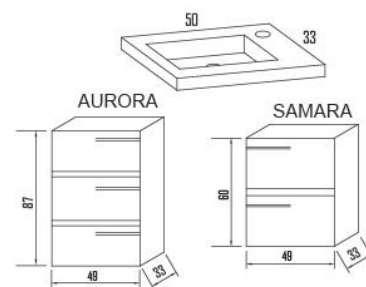

MUEBLE + LABAVO DE CARGA MINERAL + ESPEJO LISO

CONJUNTO	BLANCO O LAMINADO	COLOR	SIN ESPEJO
49x87x33	437 €	483 €	-33 €
49x60x33	396 €	436 €	-33 €

COLORES VER PÁG. 21



MINI TOLEDO

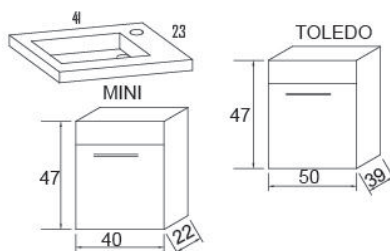

	CONJUNTO	LACA
TOLEDO	50x47x39	210 €
MINI	40x47x22	185 €



SLIM

Mueble SLIM + lavabo
450 x 250 x 600



206€

CONJUNTO COMPUESTO POR:
MUEBLE + LAVABO + ESPEJO LISO

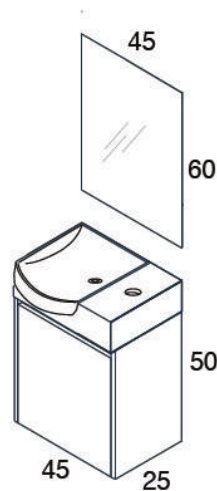

N° 4 N° 5 N° 6 N° 12

LAMINADOS / MDF



HERA 213



ROBLE OLMO



NEBRASKA



SIROKO



NOGAL
CANALETE



NOGAL
MOTSIA



PINO BLANCO



FRESNO
TAIGA 215



CEMENTO
APOLO 85



SEGARE
NATURA 202



SMOKY 211



APALACHE 212



VIRGINIA 210



ESTEPA 214



OTHELLO 201



CASTAÑO



GRISBORO



CEMENTINO 917



GRIS
ANTRACITA



VERDITEL 91



GRIS MARENCO



AZUL CIELO
BRILLO 07



ALICE 90



AZUL CIAN 5024



BIGARO 92



OCEANO



PRIMAVERA 97



BEIG
SEMIMATE 57



MARFIL 96



VISON 1015



ARENA RGB 1002



TOSCANO 94



MOCA 150



NEGRO MATE



OCEANO



BLANCO BRILLO



NEGRO BRILLO



ROJO BRILLO



PISTACHO
BRILLO



CACAO BRILLO



BURDEOS
BRILLO



CHOCOLATE
BRILLO



LILA



AZUL
TURQUESA 60



BERENJENA



BLANCO MET.



NARCISO
MET. 95



GOLDEN 20



METAL
CHAMPAN 8



METAL BRUM 82



METAL BISTRE



AVELLANA MET.



PLATA 64



FORJA
GRAFITO



NEGRO MET.

LACAS MATE O BRILLO



París

CAJONES de alta gama HETTICH

ESPEJO LISO

cm	Referencia	PVP
50x70	21.00.131	36 €
74x70	21.00.132	41 €
90x70	21.00.133	52 €
110x70	21.00.134	69 €



cm	acab. 70 bajo+ lavabo	acab. 63-34-51 bajo+ lavabo
60	411 €	435 €
80	459 €	488 €
100	531 €	563 €
120	646 €	680 €

cm	acab. 70 bajo+ lavabo	acab. 63-34-51 bajo+ lavabo
60	330 €	350 €
80	370 €	393 €
100	433 €	460 €
120	542 €	571 €

cm	bajo+ lavabo	bajo+ lavabo + espejo liso
60	247 €	259 €
80	289 €	302 €
100	319 €	334 €
120	424 €	441 €



Mueble PARIS 3C:
Anchos: 60/80/100/120 cm
Alto: 75 cm
Fondo: 45,2 cm
PATAS / SUSPENDIDO



Mueble PARIS 2C:
Anchos: 60/80/100/120 cm
Alto: 60 cm
Fondo: 45,2 cm



Mueble PARIS 1C:
Anchos: 60/80/100/120 cm
Alto: 33,4 cm
Fondo: 45,2 cm

ACABADOS:



N°63 BLANCO BRILLO



N°70 BLANCO MATE



N°34



N°51

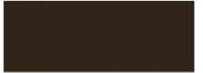

N°44



Hecho en MADERA



N° 48



N° 27

PRECIOS PARA COLORES 48/27

CM	BAJO + LAVABO	BAJO + LAVABO + ESPEJO MARCO
55cm	448 €	571 €
75cm	616 €	753 €

ASPAS



ONDAS

Etna Collection



N° 28



N° 29



N° 83



N° 70

PRECIOS COLORES 28/29/83/70

CM	BAJO + LAVABO	BAJO + LAVABO + ESPEJO MARCO
55cm	436 €	561 €
75cm	639 €	779 €

AUXILIARES	COLORES 48 Y 27	RESTO DE COLORES
COLGAR DE 42x70x20	251 €	263 €
COLUMNA 42x170x31	519 €	561 €
CAMERINO 50cm	256 €	269 €
CAMERINO 70cm	307 €	364 €
JUEGO DE APLIQUE	81 €	



Hecho en **MADERA**



Colonial Collection

PRECIOS COLORES 27/48

CM	BAJO + LAVABO	BAJO + LAVABO + ESPEJO MARCO
50	422 €	545 €
70	676 €	816 €
80	577 €	722 €
100	653 €	824 €
140	1.081 €	1.296 €

PRECIOS COLORES 28/29/83/70

CM	BAJO + LAVABO	BAJO + LAVABO + ESPEJO MARCO
50	430 €	555 €
70	700 €	846 €
80	599 €	750 €
100	712 €	891 €
140	1.123 €	1.351 €



Nº 27

Nº48

Nº 28

Nº 29

Nº 83

Nº 70

PLUS

INTEGRAL 51,5



Colonial de 50

COLONIAL 70 1P 3C

COLONIAL 80 1P 4C
COLONIAL 100 2P 4C

COLONIAL 140 2P 4C



CIRCULAR 43
Sobre-encimera

CONJUNTO 80cm



MODELO GRANADA

CONJUNTO 100cm



CONJUNTOS COMPUESTOS POR:
 ESPEJO LISO.
 ENCIMERA CERAMICA FONDO 40
 MUEBLE 1 PUERTA/ 1 PUERTA
 + 2 HUECOS / 2 PUERTAS
 CIERRE AMORTIGUADO HETTICH



CONJUNTO 70cm



CONJUNTO	LAMINADO
70x47x39	200 €
80x47x39	229 €
100x47x39	306 €
COLUMNA	138 €

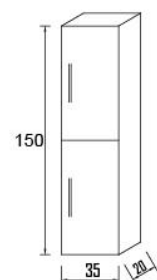
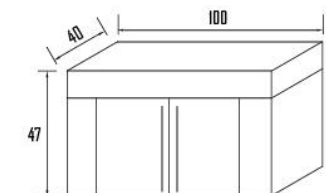
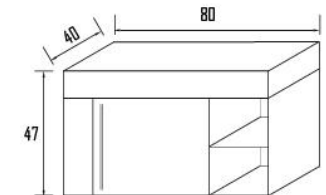
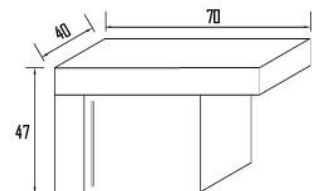

MODELO **VALENCIA**



CONJUNTO	LAMINADO
60x47x45	247 €
80x47x45	276 €
*120x47x46	530 €

*2 UNIDADES DE 60CM
ENCIMERA DE DOS SENOS

CONJUNTOS COMPUESTOS POR:
ESPEJO LISO.
ENCIMERA CERAMICA H-19
MUEBLE 2 CAJONES GUIA HETTICH

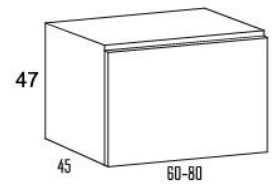

OPCIÓN ESPEJO MARCO	
80x70	+30 €
120x70	+50 €



DOBLE CAJON HETTICH

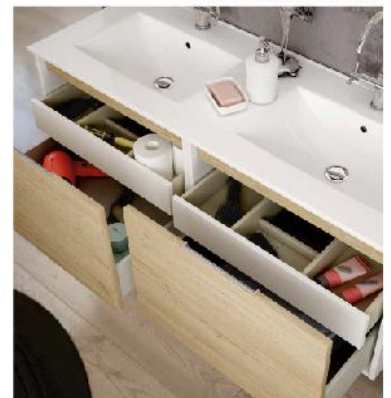

- blanco poro
- estructura
- bambú
- puertas
- hibernian
- ebony

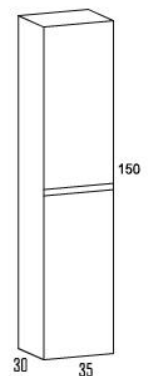

AUXILIAR	LAMINADO
35x150x30	138 €

MODELO
HERMES

CONJUNTO	LACA
60x60x45	272 €
70x60x45	297 €
80x60x45	311 €
100x60x45	378 €
120x60x45	536 €
*140X60X45	912 €

*2 UNIDADES 70 CON ENCIMERA CERAMICA DOS SENOS H-19

120

COMPACTO

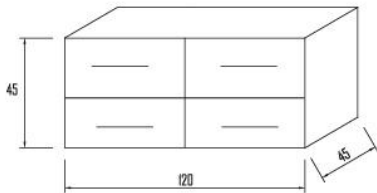

60 70 80 100

acabados

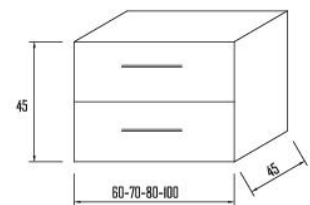
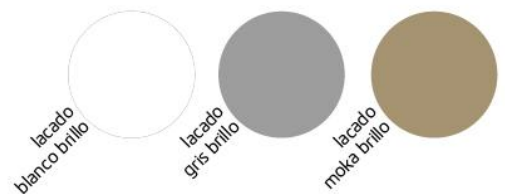

CONJUNTOS COMPUESTOS POR:
ESPEJO LISO.
ENCIMERA CERAMICA H-19
MUEBLE 2 CAJONES GUIA HETTICH



MODELO **INGLET-2**

CONJUNTO	LAMINADO	LACA
60x60x45	252 €	287 €
70x60x45	277 €	314 €
80x60x45	290 €	331 €
100x60x45	350 €	395 €
*120x60x46	539 €	609 €
*140x60x46	872 €	950 €

*2 UNIDADES DE 60/70 CM ENCIMERA DOS SENOS

CONJUNTOS COMPUESTOS POR:
ESPEJO LISO.
ENCIMERA CERAMICA H-19 (EN 140 MOD. CALPE 2 SENOS)
MUEBLE 2 CAJONES GUIA HETTICH

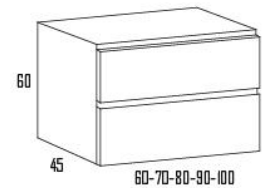

BLANCO



GRIS



EBONY



BAMBU



HIBERNIAN



CAJON HETTICH



MODELO **INGLET-3**

CONJUNTO	LAMINADO	COLOR
60x87x45	317 €	358 €
70x87x45	363 €	394 €
80x87x45	379 €	418 €
100x87x45	432 €	489 €
120x87x46	670 €	752 €
140x87x46	1.041 €	1.106 €

*2 UNIDADES DE 60/70 CM

CONJUNTOS COMPUESTOS POR:
ESPEJO LISO.
ENCIMERA CERAMICA H-19 (EN 140 MOD. CALPE 2 SENOS)
MUEBLE 2 CAJONES GUIA HETTICH

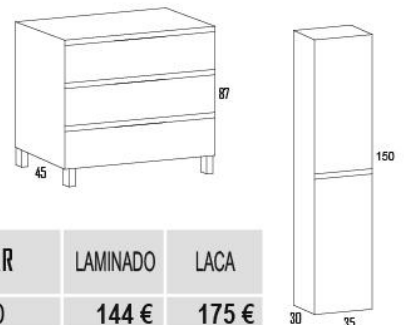

AUXILIAR	LAMINADO	LACA
35x150x30	144 €	175 €



HIBERNIAN



CAMBRIAN



BRITANIA



CAJON HETTICH



MODELO TERRA

CONJUNTO	LAMINADO
80x50x45	338 €
100x50x45	390 €
120x50x46	433 €

CONJUNTOS COMPUESTOS POR:
ESPEJO LISO.
LAVABO SOBRE ENCIMERA K-40
MUEBLE 2 CAJONES + 2 HUECOS
GUIA HETTICH

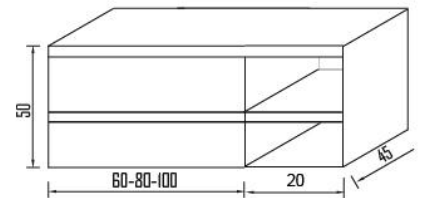

MODELO VENUS

CONJUNTO	LAMINADO
80x50x45	337 €
100x50x45	438 €
120x50x46	534 €

CONJUNTOS COMPUESTOS POR:
ESPEJO LISO.
ENCIMERA CERAMICA H-19 IZQ
MUEBLE 2 CAJONES + 2 HUECOS
GUIA HETTICH

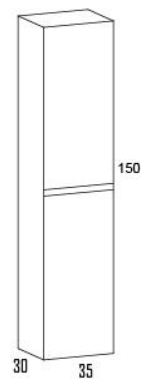

HIBERNIAN



CAMBRIAN



BRITANIA



CAJON HETTICH



AUXILIAR	LAMINADO
35x150x30 (2 puertas)	138 €

CAMERINOS

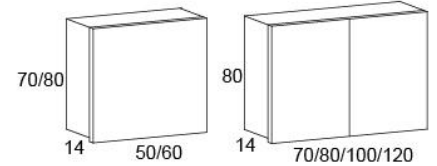

	CONJUNTO	LAMINADO
* 50x70x14 1p		85 €
60x80x14 1p		96 €
70x80x14 2p		106 €
80x70x14 2p		109 €
100x80x14 2p		140 €
* 120x80x14 2p		192 €

*2 UNDS DE 60cm

AUXILIARES

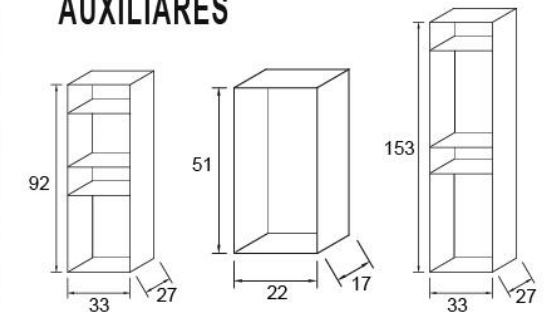

	CONJUNTO	LAMINADO
33x153x27		88 €
33x92x27		75 €
22x51x17		42 €
33x33x17		42 €



SERIE SIRI

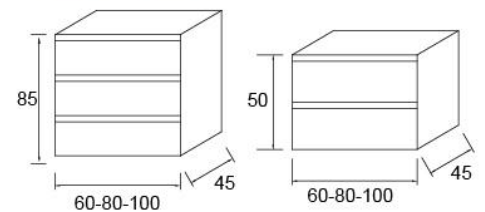

CONJUNTO	2 CAJONES	3 CAJONES
60x60x45	250 €	295 €
80x60x45	276 €	332 €
100x60x45	342 €	398 €
*120x60x46 4/6C	530 €	624 €

*2 MUEBLES 60cm Y ENCIMERA DE DOS SENOS

ESPEJOS LED

ALCOR



IZAR



ARIES



REFERENCIA	ANCHO	ALTO	GROSOR	TEMP.	LUMENES	POTENCIA	PVP
ALCOR	60	80	0,4	6400	800	9,6	121
	100				1000	9,6	150
IZAR	80	80	0,4	6400	900	9,6	121
	100				1000	9,6	150
ARIES	60	80	0,4	6500	900	9,6	145
	70				900	9,6	160

ESPEJOS DECOR

BASIC

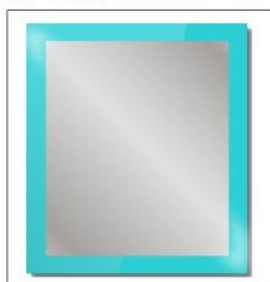

Detalle



CK 14	CK 01	CKS27	CK 03
CEZ01	CKS06	CK28	CK 07
CK 15	CK 18	CK 17	CK 17F
CKS25	CK 01B	CKS07	CK 11
CKS26	CK 02	CKST7	CK 12A
	NEG		CK 16

LUXE



Detalle



REFERENCIA	ANCHO	ALTO	GROSOR	PVP
BASIC	cm	cm	cm	€
	60	80	0,4	39
	70			45
	80			50
	80	100		64

Espejo multiposicional de 4mm liso con marco de cristal integrado de 4cm

REFERENCIA	ANCHO	ALTO	GROSOR	PVP
LUXE	cm	cm	cm	€
	60	80	1	58
	70			64
	80			69
	80			100

Espejo de cristal de 4mm liso con marco de cristal trasero de 6cm

ESPEJOS LISOS

REFERENCIA	ANCHO	ALTO	GROSOR	PVP
ESPEJO LUNA	cm	cm	cm	€
	60	80	0,8	33
	70			36
	80			39
	70	90		45
	80	100		47

Detalle



REFERENCIA	ANCHO	ALTO	GROSOR	PVP
TREBOL	cm	cm	cm	€
	50	80	1,9	45
	60			45
	70			51
	80			53
	90			55
	100			57
	120		82	

Detalle



APLIQUES

BACO 28cm



GUERRO



EROS 30cm



Referencia	Temperatura	Lúmenes	Tipo LED	Potencia	Tensión	IRC	IP	PVP
01BACO1-006T30FI120PLT44B	3000 - Cálida	290	SMD 2835	6	220-240	>80	44	30 €
01BACO2-006T60FI120PLT44B	6000 - Fría	310						
01EROS1-006T30FI120PLT44B	3000 - Cálida	280	SMD 2835	6	220-240	>80	44	42 €
01EROS2-006T60FI120PLT44B	6000 - Fría	290						
5002/1-10WAL	6500 - Fría	1000	SMD 5730	10	230	80	44	52 €
5008/1-10WAL	6500 - Fría	1000	SMD 5730	10	230	80	44	57 €
5088/30-10WAL	6500 - Fría	1000	SMD 5730	10	230	80	44	68 €
5088/40-11WAL		1100		11				74 €
5088/50-12WAL		1200		12				90 €
GUERRERO /30-10WAL	6500 - Fría	1000	SMD 5730	10	230	80	44	40 €
GUERRERO /40-11WAL		1100		12				47 €
GUERRERO /50-12WAL		1200		13				60 €

ENCIMERA H-19

ENCIMERA CERAMICA H-19 F-40/46



Referencia	Ancho	Fondo	PVP
H-19	cm	cm	€
Cerámica*51x40	51	40	82 €
Cerámica*61x40	61		82 €
Cerámica*71x40	71		89 €
Cerámica*81x40	81		97 €
Cerámica*91x40	91		121 €
Cerámica*101x40	101		140 €
Cerámica*61x46	61	46	70 €
Cerámica*71x46	71		77 €
Cerámica*81x46	81		83 €
Cerámica*91x46	91		106 €
Cerámica*101x46	101		130 €
Cerámica*121x46	121		185 €
2 senos			€
Cerá2*121x46	121	46	220 €

ENCIMERA CERAMICA H-19 F-46 DOBLE SENO



ENCIMERA CERAMICA H-19 F-46 DESPLAZADA DRCH./IZQ.



Referencia	Ancho	Fondo	PVP
Desplazada	cm	cm	€
Cerámica*81x46l	81	46	120 €
Cerámica*91x46l	91		150 €
Cerámica*101x46l	101		208 €
Cerámica*121x46l	121		295 €

Referencia	Ancho	Fondo	PVP
H-19	cm	cm	€
Cerámica*51x40	51	40	74 €
Cerámica*61x40	61		80 €
Cerámica*71x40	71		92 €
Cerámica*81x40	81		103 €
Cerámica*61x46	61	46	81 €
Cerámica*71x46	71		92 €
Cerámica*81x46	81		100 €
Cerámica*91x46	91		127 €
Cerámica*101x46	101		145 €
Cerámica*121x46	121		209 €
2 senos			
Cerá2*121x46	121	46	277 €
Cerá2*141x46	141		516 €

ENCIMERA CERAMICA CALPE F-46



CALPE



ENCIMERA CERAMICA CALPE F-46 DOBLE SENO



Referencia	Ancho	Fondo	PVP
Desplazada	cm	cm	€
Cerámica*101x46l	101	46	250 €
Cerámica*121x46l	121		345 €

ENCIMERA CERAMICA CALPE F-46 DESPLAZADA DRCH./IZQ.



ENCIMERA CURVA CRISTAL



Referencia	Ancho	Fondo	PVP
CURVA	cm	cm	€
crystal 61x 46	61	46-39	155 €
crystal 81x 46	81		185 €
crystal 101x46	101		210 €

ENCIMERA CERAMICA CRISTAL



Referencia	Ancho	Fondo	PVP
CURVA	cm	cm	€
ceramica 61x46	61	46-39	110 €
ceramica 81x46	81		138 €
ceramica 101x46	101		185 €

ENCIMERA CRISTAL MASA BLANCA FABRICACIÓN A MEDIDA 60 € CORTE



SENO CENTRADO

Referencia	Ancho	Fondo	PVP
Cristal W 1 seno	cm	cm	€
S12*61	61	40/46	166 €
S12*71	71		194 €
S12*81	81		208 €
S12*91	91		236 €
S12*101	101		264 €
S12*121	121		305 €

ENCIMERA CRISTAL MASA BLANCA FABRICACIÓN A MEDIDA 60 € CORTE



SENO DESPLAZADO

Referencia	Ancho	Fondo	PVP
Cristal W izq drch	cm	cm	€
S13*81X46	81	46	236 €
S13*101X46	101		291 €
S13*121X46	121		333 €

ENCIMERA CRISTAL MASA BLANCA FABRICACIÓN A MEDIDA 60 € CORTE



DOBLE SEÑO

Cristal W 2 senos	cm	cm	€
S16*121X46 (2 senos)	121	46	389 €
S16*141X46 (2 senos)	141		444 €
S16*161X46 (2 senos)	161		500 €

ENCIMERA DE RESINA CON GELT-COAT



Referencia	Ancho	Fondo	PVP
RESINA GELT-COAT	cm	cm	€
027B6007	60	36	70 €
027B8010	80		83 €
027B8045	80	45	83 €
027B1045	100		130 €
027B8006D*	80		83 €

(*)DESPLAZADA DERECHA

ENCIMERA CRISTAL TEMPLADO



Referencia	Ancho	Fondo	PVP
Cristal	cm	cm	€
S12*51X40	51	40/46	111 €
S12*61X40	61		111 €
S12*71X40	71		116 €
S12*81X40	81		125 €
S12*91X40	91		144 €
S12*101X40	101		159 €
S12*121X40	121		192 €
S16*121X46 (2 senos)	121	46	305 €
S16*141X46 (2 senos)	141		333 €



SOKAR SOBRE ENCIMERA



Referencia	Ancho	Fondo	Alto	PVP
Sokar	cm	cm	cm	€
Sokar	39,5	39,5	15,5	99,00

ISIS SOBRE ENCIMERA



Referencia	Ancho	Fondo	Alto	PVP
Isis	cm	cm	cm	€
Isis	46	37	13	99,00

OSIRIS SOBRE ENCIMERA



Referencia	Ancho	Fondo	Alto	PVP
Osiris	cm	cm	cm	€
CL06	47	47	17	72,00

AMÓN SOBRE ENCIMERA



Referencia	Ancho	Fondo	Alto	PVP
Amón	cm	cm	cm	€
Amón	42	42	12	99,00

K-40 SOBRE ENCIMERA



Referencia	Ancho	Fondo	Alto	PVP
K-40	cm	cm	cm	€
K-40	40,5	40,5	16,5	95,00

FINO OVALO SOBRE ENCIMERA



Referencia	Ancho	Fondo	Alto	PVP
Fino Ovalo	cm	cm	cm	€
Fino Ovalo	60,5	40	14,5	115,00

FINO K-45 SOBRE ENCIMERA



Referencia	Ancho	Fondo	Alto	PVP
Nunet	cm	cm	cm	€
Fino k-45	45,5	35,5	12	95,00

RONDA SOBRE ENCIMERA



Referencia	Ancho	Fondo	Alto	PVP
Ronda	cm	cm	cm	€
Ronda	40,5	40,5	14,5	60,00

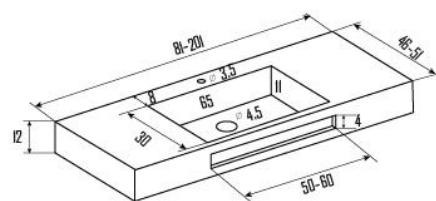
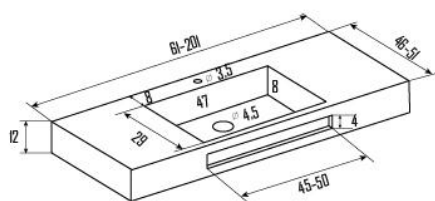
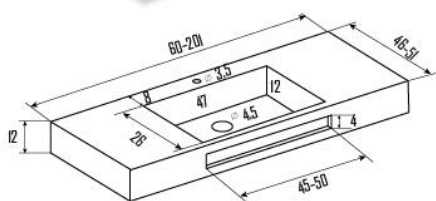
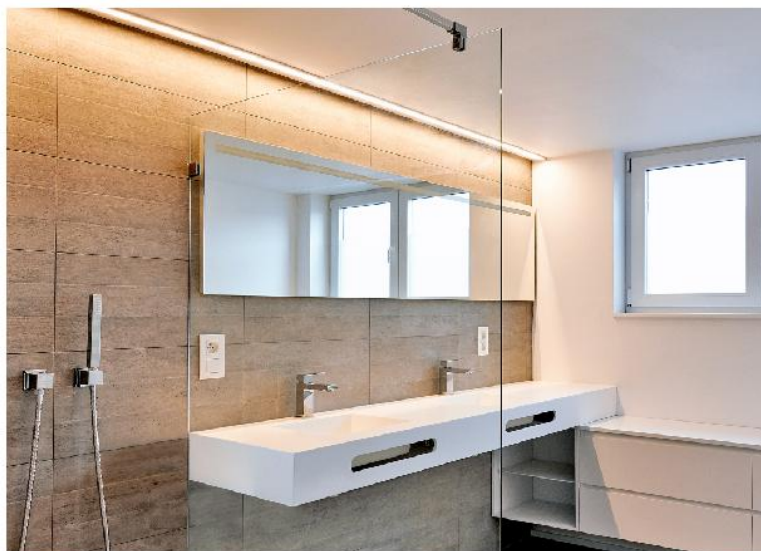

ILLICE

IDEAL

IBIZA

	SIN FALDÓN	CON FALDÓN	SIN FALDÓN - 2 SENOS	CON FALDÓN - 2 SENOS
61 X 46 - 51	180 €	269 €		
71 X 46 - 51	211 €	319 €		
81 X 46 - 51	241 €	360 €		
91 X 46 - 51	269 €	406 €		
101 X 46 - 51	300 €	455 €		
121 X 46 - 51	388 €	585 €	510 €	690 €
141 X 46 - 51	419 €	630 €	570 €	783 €
151 X 46 - 51	450 €	680 €	600 €	827 €
161 X 46 - 51	477 €	719 €	630 €	865 €
171 X 46 - 51	508 €	765 €	658 €	915 €
181 X 46 - 51	538 €	825 €	690 €	975 €
191 X 46 - 51	566 €	855 €	719 €	1.005 €
201 X 46 - 51	597 €	897 €	750 €	1.049 €

Condiciones especiales P.V.P.

*Las encimeras que superan las medidas estándar se tarifican a la medida superior.

*Copete trasero/lateral: **0,75 / cm lineal**. Los copetes se venden sueltos para instalar por el cliente.

*Color estándar: blanco mate (liso y pizarra).

*Otros colores: Incremento en un **30%** del valor de la encimera.

*Medidas especiales: **84€ corte**.

*Seno extra: **150€**.

*Juego soportes: galvanizados **47€**.

*Juego soportesinoxidable: **70€**.

Repisas sin senos PVP:

*Repisas o baldas sin faldón: 2,25€ / cm lineal.

*Repisas o baldas con faldón: 3,85€ / cm lineal.

*Los taladros redondos para grifos y desagües de lavabos van incluidos en el precio.

*Los desagües cuadrados tienen un incremento de 84€

*Importante: mandar planos con las medidas especificando distancias de grifo y desagüe.

ACCESORIOS DE BAÑO

SERIE AGATA



SERIE MINI



Referencia	Producto	Medida	PVP	Referencia	Producto	Medida	PVP
Agata	Agata	cm	€	Mini	Mini	cm	€
H9950/60	TOALLERO BARRA	660x65x85	43	H5510/50	TOALLERO BARRA	540x45x80	24
H9950/04	TOALLERO ANILLA	225x190x60	29	H5510/04	TOALLERO ANILLA	190x130x55	18
H9950/12	PORTAROLLO RESERVA	189x80x59,5	18	H5510/12	PORTAROLLO RESERVA	60x160x75	22
H9950/06	PORTAROLLO	145x160x90	22	H5510/06	PORTAROLLO	125x130x55	19
H9950/09D	PERCHA DOBLE	85x80x65	16	H5510/09	PERCHA	45x45x55	10
H9950/16	PORTAVASOS	75x100x110	24	H5510/16	PORTAVASOS	70x95x110	16
H9950/11	DOSIFICADOR	75x170x110	37	H5510/11	DOSIFICADOR	70x95x110	36
H9950/10	ESCOBILLERO	115x350x135	55	H5510/10	ESCOBILLERO	115x370x135	30

PORTES PAGADOS 166€ PVP

ACCESORIOS DE BAÑO

SERIE APOLO



SERIE IMPERIAL



Referencia	Producto	Medida	PVP	Referencia	Producto	Medida	PVP
Apolo	Apolo	cm	€	Imperial	Imperial	cm	€
H3300/60	TOALLERO BARRA	590x25x70	37	H3000/50	TOALLERO BARRA	590x25x70	76
H3300/04	TOALLERO ANILLA	230x110x70	25	H3000/06	PORTAROLLO	155x30x90	35
H3300/12	PORTAROLLO RESERVA	175x30x70	20	H3000/0411	TOALLERO DOSIFICADOR	330x30x80	66
H3300/06	PORTAROLLO	150x80x700	22	H3000/10	ESCOBILLERO	110x400x105	63
H3300/09	PERCHA	25x75x70	14	H4007	TOALLERO DOBLE SUELO	280x1020x200	220
H3300/16	PORTAVASOS	150x95x90	19	H4015/L	ESCOBILLERO SUELO	150x630x90	189
H3300/11	DOSIFICADOR	160x170x90	37	HE1306	ESPEJO DE AUMENTO	420x210x420	39
H3300/10	ESCOBILLERO	180x330x110	29	H90001	ESPEJO DE AUMENTO	135x210	47

PORTES PAGADOS 166€ PVP

ACCESORIOS DE BAÑO

SERIE ELEGANCE



SERIE CELESTE



Referencia	Producto	Medida	PVP	Referencia	Producto	Medida	PVP
Elegance	Elegance	cm	€	Celeste	Celeste	cm	€
H8700/50	TOALLERO BARRA	520X55X65	49	H4020/45	TOALLERO BARRA	450x55x62	48
H8700/05	TOALLERO ANILLA	210X115X65	36	H4020/04	TOALLERO ANILLA	200x105x60	46
H8700/04	TOALLERO ANILLA	240X145X65	49	H4020/12	PORTAROLLO RESERVA	140x100x60	36
H8700/06	PORTARROLLO	150X140X110	40	H4020/06	PORTARROLLO	150x140x110	44
H8700/09D	PERCHA DOBLE	95X65X65	25	H4020/09D	PERCHA DOBLE	90x60x60	28
H8700/12	PORTARROLLOS DE RESERVA	160X55X85	26	H4020/09	PERCHA	55x60x60	21
H8700/DO	DOSIFICADOR	60X180X50	48	H4020/DO	DOSIFICADOR	50x180x60	48
H8700/20	ESCOBILLERO	90X400X100	74	H4020/20	ESCOBILLERO	90x400x100	72

PORTES PAGADOS 166€ PVP

ACCESORIOS DE BAÑO

SERIE PERLA



SERIE INOX BRILLO



Referencia	Producto	Medida	PVP	Referencia	Producto	Medida	PVP
Perla	Perla	cm	€	Inox 304	Inox 304	cm	€
H2001/50	TOALLERO BARRA	540X45X65	25	HI7222/50	TOALLERO BARRA	500X53X80	29
H2001/05	TOALLERO ANILLA	185X185X65	24	HI7222/04	TOALLERO ANILLA	240X150X85	28
H2001/04	TOALLERO ABATIBLE	190X135X65	18	HI7222/12	PORTAROLLO RESERVA	58X170X95	24
H2001/06	PORTAROLLO	120X105X145	20	HI7222/06	PORTAROLLO	130X40X130	25
H2001/09	PERCHA	50X60X65	10	HI7222/09D	PERCHA DOBLE	53X53X60	14
H2001/63	PORTAROLLO RESERVA	160X50X65	18	HI7222/16	PORTAVASOS	67X95X105	19
H2001/12	PORTAROLLO RESERVA	60X160X85	22	HI7222/15	JABONERA	110X53X125	19
H2001/10	ESCOBILLERO	165X335X105	30	H25500	ESCOBILLERO	95X360	65

PORTES PAGADOS 166€ PVP

ACCESORIOS DE BAÑO

SERIE DUBE



SERIE HOTEL

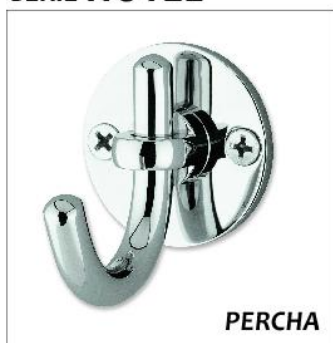

Referencia	Producto	Medida	PVP	Referencia	Producto	Medida	PVP
Dube	Dube	cm	€	Hotel	Hotel	cm	€
90201	TOALLERO BARRA	520x62x40	45	90928	PERCHA	40x50x58	15
90202	TOALLERO BARRA DOBLE	520x112x40	70	90929	PERCHA TRIPLE	155x58x48	25
90208	TOALLERO ANILLA	215x67x147	42	90922	PORTAROLLO RESERVA	60x225x100	25
90204	PORTAROLLO	205x69x147	25	90923	TOALLERO ANILLA		22
90205	PERCHA	70x40x40	16	90924	JABONERA	118x136x66	20
90206	PORTAVASOS	87x104x100	36	90925	PORTAVASOS	74x116x103	20
90207	JABONERA	120x151x47	32	90926	PERCHA DOBLE	117x69x64	16
90209	ESCOBILLERO	115x130x355	50	90927	PERCHA SIMPLE	57x80x70	14

PORTES PAGADOS 166€ PVP



RADIADOR TOALLERO

DE CALEFACCIÓN CROMADO

MEDIDAS	TUBOS	POTENCIA		PVP
cm	unds	kcal/h	wat/h	€
80x50x45	17	227	264	128
118x50x45	27	352	409	200
150x50x45	32	426	496	272

DE CALEFACCIÓN BLANCO

MEDIDAS	TUBOS	POTENCIA		PVP
cm	unds	kcal/h	wat/h	€
80x50x45	17	292	339	67
118x50x45	27	450	523	92
150x50x45	32	546	634	114

JUEGO DE ESCUADRA Y DETENTOR CROMADO

40 €

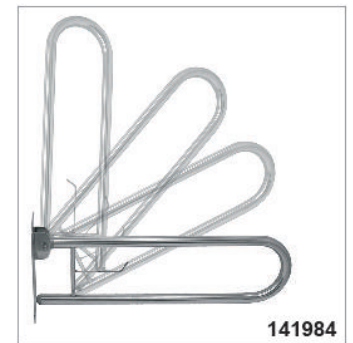

CODIGO	DESCRIPCION	€
151424	HIDRO ESCOBILLA AGUA FRIA Y CALIENTE	99 €
152964	HIDRO ESCOBILLA AGUA FRIA Y CALIENTE	115 €
321034	PORTARROLLOS/ TOALLERO BIDE MUEBLE	22 €
321054	TOALLERO SIN TALADRO PARA MUEBLE 29cm	29 €
321044	TOALLERO SIN TALADRO PARA MUEBLE 36cm	29 €
141024	BANQUETA REGULABLE EN ALTURA ALUMINIO	50 €
140734	ASIENTO DE DUCHA ABATIBLE CON PATAS	97 €
140744	ASIENTO DE DUCHA ABATIBLE	57 €
141984	ASA DE SEGURIDAD ABATIBLE INOX. 304	105 €
141301	ASA DE SEGURIDAD LISA INOX. 304 25cm	17 €

CODIGO	DESCRIPCION	€
140492	ASA DE SEGURIDAD LISA INOX. 304 30cm	20 €
140512	ASA DE SEGURIDAD LISA INOX. 304 40cm	23 €
142934	ASA DE SEGURIDAD LISA INOX. 304 50cm	28 €
141341	ASA DE SEGURIDAD ANTIDESLIZANTE INOX. 304 25cm	20 €
140502	ASA DE SEGURIDAD ANTIDESLIZANTE INOX. 304 30cm	23 €
140522	ASA DE SEGURIDAD ANTIDESLIZANTE INOX. 304 40cm	26 €
143024	ASA DE SEGURIDAD ANTIDESLIZANTE INOX. 304 50cm	30 €
90905	ASA DE SEGURIDAD ANGULAR	41 €
90906	ASA DE SEGURIDAD ANGULAR CON JABONERA	51 €

COMPLEMENTOS DE BAÑO

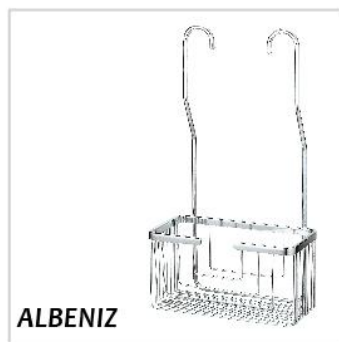
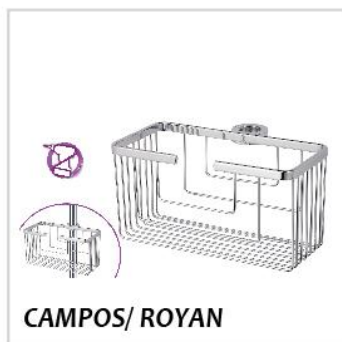

CODIGO	DESCRIPCION	€
131624	CESTA SIN TALADROS CAMPOS LATON CROMADO	45 €
131694	CESTA SIN TALADROS MONTERO ALUMINIO	37 €
131614	CESTA SIN TALADROS ALVAREZ LATON CROMADO	48 €
131684	CESTA SIN TALADROS ROYAN ALUMINIO	39 €
130034	CESTA SIN TALADROS ALBENIZ LATON CROMADO	49 €
131524	CESTA SIN TALADROS GARCIA ALUMINIO	30 €
130064	PORTAGEL AZORIN 12 LATON CROMADO	30 €
130044	PORTAGEL ALDANA 8 LATON CROMADO	28 €
130024	PORTAGEL ACOSTA DOBLE LATON CROMADO	58 €

CODIGO	DESCRIPCION	€
130014	PORTAGEL ALBA 14 LATON CROMADO	32 €
90913	PORTAGEL 90913 LATON CROMADO (304X134X80)	38 €
90912	PORTAGEL 90912 LATON CROMADO (224X115X110)	30 €
90919	PORTAGEL DOBLE 90919 LATON CROMADO	86 €
90915	PORTAGEL DOBLE 90915 LATON CROMADO	45 €
322994	TOALLERO ABATIBLE INOX 4 PERCHAS	65 €
90901	TOALLERO PARED 90901 LATON CROMADO	75 €
90902	TOALLERO PARED 90902 LATON CROMADO	70 €
90203	TOALLERO PARED 90903 LATON CROMADO	107 €

COMPLEMENTOS DE BAÑO



90917



90916

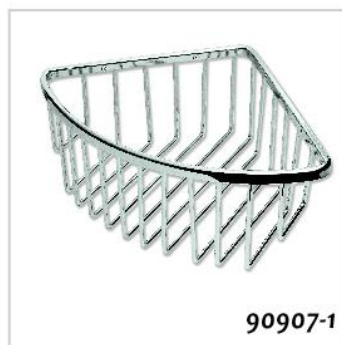

90907-1



90911



SIFON REDONDO



90909



90910



90914



LATON

VALVULA CLICK CORTA



LATON

VALVULA CLICK LARGA



CERAMICA

VALVULA CLICK CORTA



CERAMICA

VALVULA CLICK LARGA



CUBO PEDAL 3L



CUBO PEDAL 5L



APERTURA POR SENSOR

CUBO ARALIA 5L



APERTURA POR SENSOR

CUBO CACTUS 12L

CODIGO	DESCRIPCION	€
90917	PORTAGEL 90917 LATON CROMADO	42 €
90916	PORTAGEL 90916 LATON CROMADO	34 €
90907-1	PORTAGEL 90907-1 LATON CROMADO	35 €
90911	PORTAGEL DOBLE 90911 LATON CROMADO	67 €
183874	SIFON REDONDO LATON CROMADO	30 €
90909	PORTAGEL 90909 LATON CROMADO	30 €
90910	PORTAGEL 90910 LATON CROMADO	30 €
90914	PORTAGEL 90914 LATON CROMADO	43 €

CODIGO	DESCRIPCION	€
170202	VALVULA CLICK CORTA 1-1/4	14 €
170222	VALVULA CLICK LARGA TUBO 32 1-1/4	13 €
173154	VALVULA CLICK LARGA TUBO 40 1-1/2	14 €
171632	VALVULA CLICK CORTA TAPON CERAMICA 1-1/4	16 €
171512	VALVULA CLICK LARGA TAPON CERAMICA 1-1/4	15 €
90946	CUBO DE PEDAL 3L	27 €
90947	CUBO DE PEDAL 5L	30 €
	CUBO AUTOMATICO ARALIA 5L	63 €
	CUBO AUTOMATICO CACTUS 12L	66 €

GRIFERIA DE COCINA



CODIGO	DESCRIPCION	€
161724	MONOMANDO DE COCINA OSUNA	95 €
163054	MONOMANDO DE COCINA NIEVE	85 €
163044	MONOMANDO DE COCINA ZABACHE	85 €
161804	MONOMANDO DE COCINA VARELA	130 €
000801CR	MONOMANDO DE COCINA MAGNA	86 €
161664	MONOMANDO DE COCINA GOYA	100 €
161674	MONOMANDO DE COCINA DALI	97 €
000775CR	MONOMANDO DE COCINA FENIX RECTO	44 €

CODIGO	DESCRIPCION	€
000850CR	MONOMANDO DE COCINA ABATIBLE	80 €
000838CR	MONOMANDO DE COCINA DESING	67 €
160534	MONOMANDO DE COCINA CARRERA	45 €
00780CR	MONOMANDO DE COCINA ZERO	40 €
000785CR	MONOMANDO DE COCINA COLONIAL CR	47 €
000785BR	MONOMANDO DE COCINA COLONIAL BR	56 €
00081CR	MONOMANDO DE COCINA VIMO	63 €
000815CR	MONOMANDO DE COCINA 815	55 €

GRIFERIA DE BAÑO

SELF



SMILE



QUA



MAGNA



CODIGO	DESCRIPCION	€
000826CR	MONOMANDO LAVABO SELF	78 €
000825CR	MONOMANDO DE CASCADA SELF	79 €
000828CR	MONOMANDO BIDET SELF	79 €
000827CR	MONOMANDO DUCHA SELF	117 €
000801CR	MONOMANDO BAÑERA SELF	156 €
000830CR	MONOMANDO LAVABO SMILE	72 €
000831CR	MONOMANDO BIDET SMILE	72 €
000833CR	MONOMANDO DUCHA SMILE	98 €
000832CR	MONOMANDO BAÑERA SMILE	119 €

CODIGO	DESCRIPCION	€
000832CR	MONOMANDO LAVABO QUA	83 €
000838CR	MONOMANDO BIDET QUA	75 €
160534	MONOMANDO DUCHA QUA	105 €
00780CR	MONOMANDO BAÑERA QUA	110 €
000797CR	MONOMANDO LAVABO MAGNA	50 €
000798CR	MONOMANDO BIDET MAGNA	50 €
000800CR	MONOMANDO DUCHA MAGNA	64 €
000799CR	MONOMANDO BAÑERA MAGNA	81 €

GRIFERIA DE BAÑO

COLONIAL CROMO / BRONCE

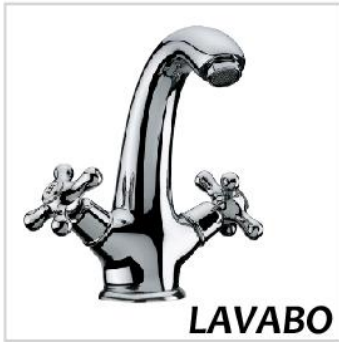

MAGIC



HOLI



SPRINT



CODIGO	DESCRIPCION	€
000781CR	MONOMANDO LAVABO COLONIAL CR	63 €
000782CR	MONOMANDO BIDET COLONIAL CR	63 €
000783CR	MONOMANDO DUCHA COLONIAL CR	53 €
000784CR	MONOMANDO BAÑERA COLONIAL CR	87 €
00781BR	MONOMANDO LAVABO COLONIAL BR	67 €
000782BR	MONOMANDO BIDET COLONIAL BR	67 €
000783BR	MONOMANDO DUCHA COLONIAL BR	69 €
000784BR	MONOMANDO BAÑERA COLONIAL BR	107 €
000765CR	MONOMANDO LAVABO SPRINT	29 €
000766CR	MONOMANDO BIDE SPRINT	29 €

CODIGO	DESCRIPCION	€
000575CR	MONOMANDO LAVABO MAGIC	52 €
000576CR	MONOMANDO BIDET MAGIC	52 €
000578CR	MONOMANDO DUCHA MAGIC	73 €
000577CR	MONOMANDO BAÑERA MAGIC	98 €
000844CR	MONOMANDO LAVABO HOLI	39 €
000845CR	MONOMANDO BIDET HOLI	39 €
000847CR	MONOMANDO DUCHA HOLI	50 €
000846CR	MONOMANDO BAÑERA HOLI	58 €
000768CR	MONOMANDO DUCHA SPRINT	43 €
000767CR	MONOMANDO BAÑERA SPRINT	47 €

GRIFERIA DE BAÑO

NADAL



VERDASCO



NADAL



SALTER



STELLA



QUA



CODIGO	DESCRIPCION	€
51474	MONOMANDO LAVABO NADAL	50 €
151484	MONOMANDO BIDET NADAL	52 €
151494	MONOMANDO DUCHA NADAL	67 €
151504	MONOMANDO BAÑERA NADAL	89 €
153714	MONOMANDO LAVABO VERDASCO	68 €
153194	MONOMANDO LAVABO VERDASCO BCO	88 €
153184	MONOMANDO DUCHA VERDASCO	89 €
153204	MONOMANDO LAVABO C/A VERDASCO	105 €
153214	MONOMANDO LAVABO C/A NADAL	99 €

CODIGO	DESCRIPCION	€
000832CR	MONOMANDO LAVABO SALTER	69 €
000838CR	MONOMANDO BIDET SALTER	69 €
160534	MONOMANDO DUCHA SALTER	95 €
00780CR	MONOMANDO BAÑERA SALTER	115 €
000821CR	TERMOSTATICA DE DUCHA ROUND	95 €
000820CR	TERMOSTATICA DE BAÑERA ROUND	115 €
000823CR	TERMOSTATICA DE DUCHA SQUARE	115 €
000822CR	TERMOSTATICA DE BAÑERA SQUARE	140 €

COLUMNAS DE DUCHA



CODIGO	DESCRIPCION	€
121004	COLUMNA DE DUCHA CANO 80-120	190 €
122104	COLUMNA DE DUCHA CANO 100-150	214 €
120724	COLUMNA DE DUCHA REDONDA 80-120	189 €
121574	COLUMNA DE DUCHA REDONDA 100-150	210 €
120704	COLUMNA DE DUCHA CUADRADA 80-120	275 €
122034	COLUMNA DE BAÑERA GASOL 80-120	380 €

CODIGO	DESCRIPCION	€
120714	COLUMNA DE DUCHA REDONDA 80-120 S/G	116 €
122064	COLUMNA DE DUCHA REDONDA 100-150 S/G	140 €
120694	COLUMNA DE DUCHA CUADRADA 80-120 S/G	155 €
122054	COLUMNA DE DUCHA CUADRADA 100-150 S/G	153 €
120704	COLUMNA DE DUCHA COLONIAL BRONCE	285 €
000819CR	COLUMNA DE DUCHA EKO-PLUS CR	151 €

KO



COLUMNAS DE DUCHA AIGA MONTES



GRIFERIA DE DUCHA PARA EMPOTRAR EN PARED

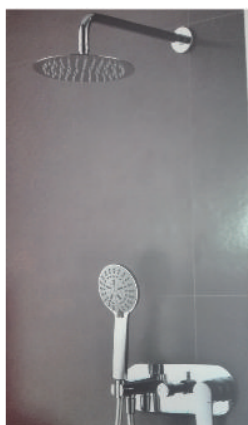

PONCE

VALDES



COMPUESTO POR:
GRIFERIA + DUCHON TECHO/PARED +SOPORTE MANGO
DE DUCHA + MANGO DE DUCHA + FLEXO



QUEVEDO



SARABIA



ABELLAN



CASILLAS

CODIGO	DESCRIPCION	€
088.	COLUMNA DE DUCHA KO MONOMANDO	300 €
088.	COLUMNA DE DUCHA KO TERMOSTATICA	355 €
087.	COLUMNA DE DUCHA AIGA MONOMANDO	335 €
087.	COLUMNA DE DUCHA AIGA TERMOSTATICA	390 €
153324	KIT DUCHA EMPOTRADA SARABIA MON. PARED	199 €
122334	KIT DUCHA EMPOTRADA QUEVEDO MON. PARED	230 €
153494	KIT DUCHA EMPOTRADA SARABIA MON. TECHO	199 €
122504	KIT DUCHA EMPOTRADA QUEVEDO MON. TECHO	230 €
121944	COLUMNA MONTES 80-120 cm Bluetooth	245 €

CODIGO	DESCRIPCION	€
153694	KIT DUCHA EMPOTRADA ABELLAN TMS. TECHO	295 €
153364	KIT DUCHA EMPOTRADA PONCE TMS. TECHO	295 €
153704	KIT DUCHA EMPOTRADA ABELLAM TMS. PARED	295 €
153684	KIT DUCHA EMPOTRADA PONCE TMS. PARED	295 €
153634	KIT DUCHA EMPOTRADA VALDES TMS. TECHO	189 €
153654	KIT DUCHA EMPOTRADA CASILLAS TMS. TECHO	215 €
153644	KIT DUCHA EMPOTRADA VALDES TMS. PARED	189 €
153664	KIT DUCHA EMPOTRADA CASILLAS TMS. PARED	215 €



085. ENSA



838. MUL



085. Ensa

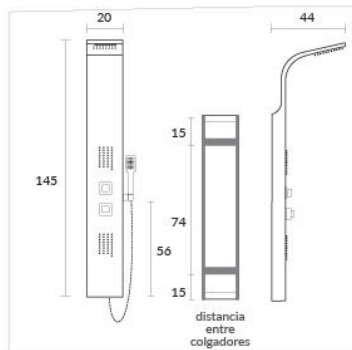

838. Mul

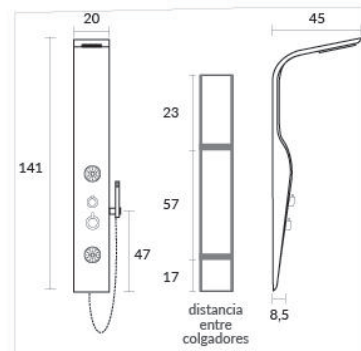

839. Woda

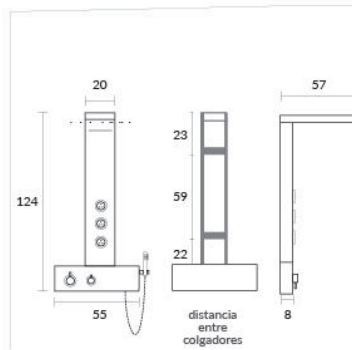

DESCRIPCION	€
COLUMNA 085. ENSA MONOMANDO	260 €
COLUMNA 085. ENSA TERMOSTATICO	295 €
COLUMNA 838. MUL MONOMANDO	325 €
COLUMNA 838. MUL TERMOSTATICO	380 €
COLUMNA 839. WODA MONOMANDO	335 €
COLUMNA 839. WODA TERMOSTATICO	390 €



FABRICADO EN SOLID SURFACE BRILLO O MATE LISO, CARGA MINERAL TEXTURA PIZARRA(ver colores de plato nature)



001.VANN
acero inox

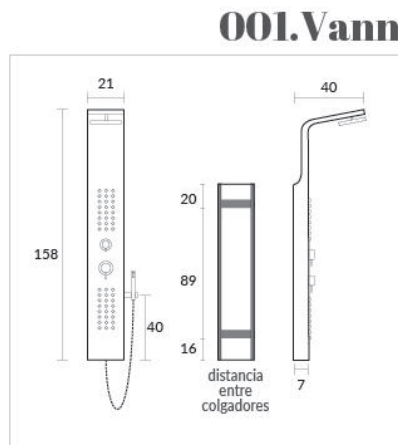
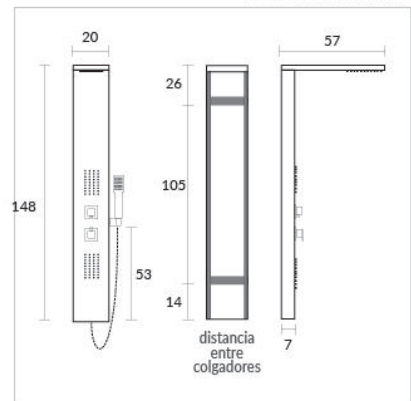
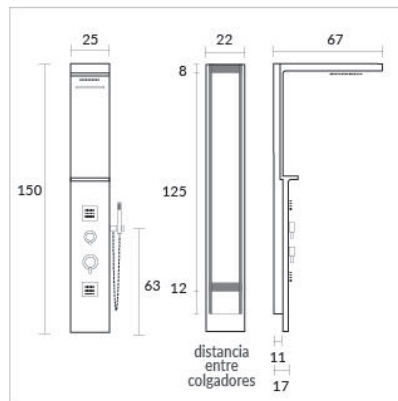

COLUMNA DUCHA NAM MATE MON.	1. 100 €
COLUMNA DUCHA NAM MATE TMS.	1.055 €
COLUMNA DUCHA NAM PIZARRA MON.	1.100 €
COLUMNA DUCHA NAM PIZARRA TMS.	1.155 €
COLUMNA DUCHA ILMA MON.	280 €
COLUMNA DUCHA ILMA TMS.	310 €
COLUMNA DUCHA VAN MON.	375 €
COLUMNA DUCHA VAN TMS.	430 €

CASTOR (2 HOJAS CORREDERAS)



MEDIDA	TRANSP.	SERIG.
HASTA 120 cm	495 €	545 €
HASTA 140 cm	540 €	590 €
HASTA 160 cm	585 €	635 €



LATERAL FIJO CASTOR		
MEDIDA	TRANSP.	SERIG.
HASTA 80 cm	250 €	275 €

SHAULA (1 HOJA FIJA + 2 CORREDERAS)



MEDIDA	TRANSP.	SERIG.
HASTA 120 cm	520 €	595 €
HASTA 140 cm	565 €	640 €
HASTA 160 cm	610 €	685 €

LATERAL FIJO SAHULA		
MEDIDA	TRANSP.	SERIG.
HASTA 80 cm	250 €	275 €



Decorado n°1



Decorado n°3



Decorado n°9



Decorado n°10



Decorado n°25



Decorado n°26

ARIEL 3000 PLUS



MEDIDA	TRANSP.	SERIG.
HASTA 80 cm	435 €	485 €
HASTA 100 cm	480 €	530 €
HASTA 120 cm	525 €	575 €
HASTA 140 cm	570 €	620 €

(1 HOJA + 1 HOJA ABATIBLE)

	CASTOR (FIJO)	SAHULA	ARIEL 3000
Altura estándar para ducha	195 cm	=	=
Altura estándar para bañera	150 cm	=	=
Extensibilidad de la mampara	+5 cm	+2,5 cm	+5 cm
Ancho mínimo	100/20 cm	90 cm	70 cm
Ancho máximo	160/120 cm	160 cm	160 cm
Altura estándar mampara	195 cm	=	=
Grosor cristal (hoja fija/puerta abatible)	6 mm / 6 mm	=	=
Cruce de puertas (mínimo/máximo)	+1,5 cm / +6 cm	=	=

SERIE CASIOPEA

KORE



ALGOL



MEDIDA	TRANSP.	SERIG.
HASTA 120 cm	389 €	439 €
HASTA 140 cm	420 €	470 €
HASTA 160 cm	455 €	505 €
HASTA 180 cm	492 €	542 €

RODAMIENTO ACERO INOX Y TEFLON



MEDIDA	TRANSP.	SERIG.
HASTA 70	290 €	340 €
HASTA 75	299 €	349 €
HASTA 80	302 €	352 €
HASTA 90	308 €	358 €
HASTA 100	319 €	369 €
HASTA 120	352 €	402 €

LATERAL FIJO KORE		
MEDIDA	TRANSP.	SERIG.
HASTA 70 cm	161 €	186 €
HASTA 75 cm	171 €	196 €
HASTA 80 cm	176 €	201 €



PARA HALLAR EL PRECIO SUMAR AMBOS LADOS

SKAT



Decorado n° 1



Decorado n° 3



Decorado n° 9



Decorado n° 10



Decorado n° 25



Decorado n° 26

DECORADOS :
SERIE DAMASCO
SERIE SEDA
SERIE CASIOPEA

	KORE	ALGOL	SKAT
Altura estándar para ducha	195 cm	=	=
Altura estándar para bañera	150 cm	=	=
Extensibilidad de la mampara	+5 cm	2,5 cm	=
Ancho mínimo	100 cm	67 cm	140 cm
Ancho máximo	210 cm	200 cm	220 cm
Altura estándar mampara	195 cm	=	=
Grosor cristal (hoja fija/puerta abatible)	8 mm / 6 mm	=	=
Cruce de puertas (mínimo/máximo)	+1,5 cm / +6 cm	=	=

MEDIDA	TRANSP.	SERIG.
HASTA 160 cm	575 €	625 €
HASTA 180 cm	605 €	655 €
HASTA 200 cm	635 €	685 €

SERIE SEDA

SEDA 1000



MEDIDA	TRANSP.	SERIG.
HASTA 120 cm	368 €	418 €
HASTA 140 cm	390 €	440 €
HASTA 160 cm	415 €	465 €
HASTA 180 cm	450 €	499 €

LATERAL FIJO KORE		
MEDIDA	TRANSP.	SERIG.
HASTA 70 cm	165 €	190 €
HASTA 75 cm	175 €	200 €
HASTA 80 cm	179 €	204 €



	1000	3000	4000
Altura estándar para ducha	195 cm	=	=
Altura estándar para bañera	150 cm	=	=
Extensibilidad de la mampara	+5 cm	2,5 cm	=
Ancho mínimo	140 cm	67 cm	140 cm
Ancho máximo	210 cm	140 cm	220 cm
Altura estándar mampara	195 cm	=	=
Grosor cristal (hoja fija/puerta abatible)	8 mm / 6 mm	=	=
Cruce de puertas (mínimo/máximo)	+1,5 cm / +6 cm	=	=

ALTURA ESPECIAL ENTRE 150-195 CM SIN INCREMENTO
ALTURA SUPERIOR A LA ESTANDAR 10% CADA 10 CM O FRACCIÓN

MEDIDA	TRANSP.	SERIG.
HASTA 160 cm	473 €	573 €
HASTA 180 cm	497 €	597 €
HASTA 200 cm	519 €	619 €

SEDA 3000



MEDIDA	TRANSP.	SERIG.
HASTA 70	231 €	281 €
HASTA 75	237 €	287 €
HASTA 80	242 €	292 €
HASTA 90	253 €	303 €
HASTA 100	265 €	315 €
HASTA 110	276 €	326 €
HASTA 120	287 €	337 €
HASTA 130	300 €	350 €
HASTA 140	312 €	362 €

PARA HALLAR EL PRECIO SUMAR AMBOS LADOS

SEDA 4000



SERIE DAMASCO

DAMASCO 1000



MEDIDA	TRANSP.	SERIG.
HASTA 120 cm	319 €	369 €
HASTA 140 cm	347 €	397 €
HASTA 160 cm	372 €	422 €
HASTA 180 cm	425 €	475 €

LATERAL FIJO KORE		
MEDIDA	TRANSP.	SERIG.
HASTA 70 cm	192 €	217 €
HASTA 75 cm	210 €	235 €
HASTA 80 cm	222 €	247 €

ANCHO MINIMO 20cm
ANCHO MAXIMO 120cm



Altura estándar para ducha	195 cm
Altura estándar para bañera	150 cm
Extensibilidad de la mampara	+5 cm
Ancho mínimo	100 cm
Ancho máximo	210 cm
Altura estándar mampara	195 cm
Grosor cristal (hoja fija/puerta abatible)	6 mm / 6 mm
Cruce de puertas (mínimo/máximo)	+1,5 cm / +6 cm

ALTURA ESPECIAL ENTRE 150-195 CM
SIN INCREMENTO
ALTURA SUPERIOR A LA ESTANDAR
10% CADA 10 CM O FRACCIÓN

MEDIDA	TRANSP.	SERIG.
HASTA 160 cm	450 €	550 €
HASTA 180 cm	477 €	577 €
HASTA 200 cm	495 €	595 €

DAMASCO 3000

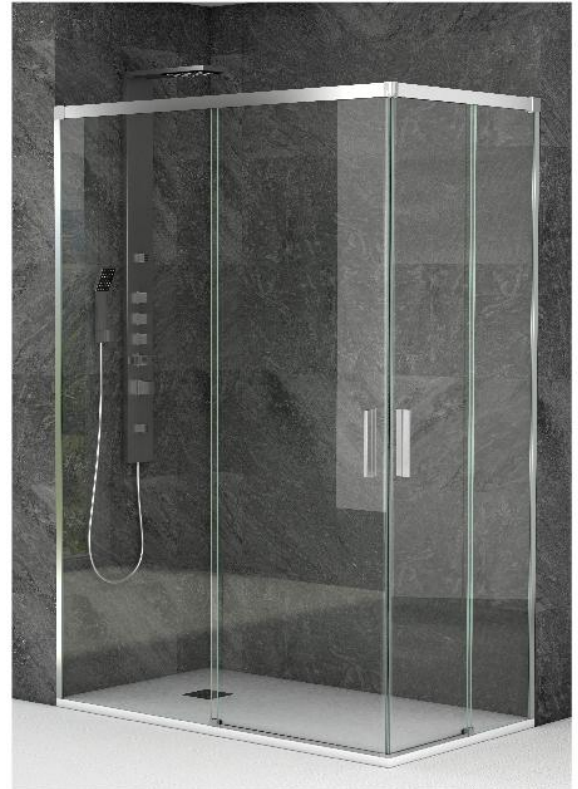

MEDIDA	TRANSP.	SERIG.
HASTA 70	220 €	281 €
HASTA 75	227 €	287 €
HASTA 80	233 €	292 €
HASTA 90	246 €	303 €
HASTA 100	260 €	315 €
HASTA 120	285 €	337 €
HASTA 130	291 €	350 €
HASTA 140	306 €	362 €

PARA HALLAR EL PRECIO SUMAR AMBOS LADOS

DAMASCO 4000



SERIE PERSEO

ACRUX



RODAMIENTO SUPERIOR REGULABLE



RODAMIENTO INFERIOR DESMONTABLE



ALTAIR



MEDIDA	RANGO	PASO	TRANSP.	SERIG.
120	117-122	48	275 €	315 €
125	122-127	50	282 €	322 €
130	127-132	52	288 €	328 €
135	132-137	54	294 €	334 €
140	137-142	56	299 €	339 €
145	142-147	58	307 €	347 €
150	147-152	60	314 €	354 €
155	152-157	62	320 €	360 €
160	157-162	64	326 €	366 €
165	162-167	66	332 €	372 €
170	167-172	68	339 €	379 €

LATERAL FIJO ACRUX / IZAR			
MEDIDA	RANGO	TRANSP.	SERIG.
70	67-69,5	139 €	159 €
75	72-74,5	145 €	165 €
80	77-79,5	150 €	170 €



50 € POR MAMPARA

MEDIDA	RANGO	TRANSP.	SERIG.
70	67-69,5	162 €	202 €
75	72-74,5	168 €	208 €
80	77-79,5	174 €	214 €
90	87-89,5	186 €	226 €
100	97-99,5	198 €	238 €
110	107-109,5	223 €	263 €
120	117-119,5	223 €	263 €
140	137-139,5	245 €	295 €

IZAR



Decorado nº 1



ANTARES

MEDIDA	RANGO	TRANSP.
80	77-79,5	343 €
90	87-89,5	361 €



ANTICAL 50€ POR MAMPARA

MEDIDA	RANGO	PASO	TRANSP.	SERIG.
160	157-162	64	370 €	450 €
165	162-167	66	377 €	457 €
170	167-172	68	383 €	463 €
175	172-177	70	390 €	470 €
180	177-182	72	396 €	476 €
185	182-187	74	402 €	482 €
190	187-192	76	408 €	488 €
195	192-197	78	414 €	494 €
200	197-202	80	420 €	500 €



COSMOS



ASTRO



MEDIDA	TRANSP.	SERIG.
HASTA 120 cm	320€	360 €
HASTA 140 cm	330€	370 €
HASTA 160 cm	340€	380 €
HASTA 180 cm	360€	400 €

NOVEDAD CROMOS ESPECIALES



MEDIDA	TRANSP.	SERIG.
HASTA 160cm	420€	500€
HASTA 180cm	440€	520€
HASTA 200cm	460€	540€
HASTA 220cm	480€	560€
HASTA 240cm	500€	580€

VOLANTIS (1 HOJA FIJA + 1 CORREDERA)



ESTRELLA CON LATERAL FIJO 8mm



MEDIDA	TRANSP.	SERIG.
HASTA 120 cm	320€	360 €
HASTA 140 cm	330€	370 €
HASTA 160 cm	340€	380 €
HASTA 180 cm	360€	400 €

Medidas superiores en alto o ancho **+38,00€** cada 10 cm.
Por forma **+ 55,00€** cada pieza.
Acabados en cromo (Azul, Rojo y Negro) **+50,00€ (NOVEDAD)**
Cambio de Asa o Uñero **+ 25,00€/Ud.**
Para bañera descuento 5%.

NOVEDAD Incremento por vidrio en espejo (MIRASTAR) 6 mm 120,00€.

MEDIDA	TRANSP.	SERIG.
HASTA 180 cm	450€	510 €
HASTA 200 cm	470€	530 €
HASTA 220 cm	490€	550 €
HASTA 240 cm	510€	570 €

ZIRCÓN ALTURA 2 METROS (3 HOJAS CORREDERAS)



MEDIDA	TRANSP.	SERIG.
HASTA 120 cm	445 €	485 €
HASTA 140 cm	465 €	505 €
HASTA 160 cm	485 €	525 €
HASTA 180 cm	505 €	545 €

SOLO CRISTAL DE 6/mm

TELLA ALTURA 2 METROS (1 HOJA FIJA+1 HOJA ABATIBLE + TIRANTE 90°)



MEDIDA	TRANSP.	SERIG.
80+25	230 €	275 €
80+40 / 90+25	240 €	285 €
90+40 / 100+25	250 €	295 €
100+40 / 110+25	260 €	305 €
110+40 / 120+25	270 €	315 €
120+40	280 €	325 €



ARCOIRIS ALTURA 2 METROS (1 HOJA FIJA TIRANTE 90°/45)



MEDIDA	TRANSP.	SERIG.
6/mm 80 cm	187 €	207 €
6/mm 90 cm	197 €	217 €
6/mm 100 cm	207 €	227 €
6/mm 110 cm	217 €	237 €
6/mm 120 cm	227 €	247 €

LIBO ALTURA 2 METROS (1 HOJA FIJA+1 HOJA ABATIBLE CON BISAGRA +TIRANTE 90°)



MEDIDA	TRANSP.	SERIG.
80+30cm	260 €	280 €
100+30cm	305 €	325 €

Medidas superiores en alto o ancho **+38,00€** cada 10 cm.
Por forma **+ 55,00€** cada pieza.

Cristal de **8 mm**. Incremento de **20%** del PVP
Para bañera descuento **5%**.

NOVEDAD Incremento por vidrio en espejo (MIRASTAR) 6 mm **120,00€**.

SERIE CLASIC (ACRILICA Y CRISTAL)

DIANA ALTURA 185 cm



MODELO	AC. CRISTAL	AC. PERFIL	MED. CON PERFIL	PVP
VENECIA	TRANSP/SRGR	ALUM. BRILLO	84X147X,05cm	125 €
VERONA	TRANSPARENTE	ALUM. BRILLO	(68+52)X147X0,5cm	209 €

* Toallero de latón cromado

PARA MODELOS DIANA-MERCURIO-URANO-SELENE



MEDIDA	ACRÍLICO	TRANSP.	SERIGRAFÍA
hasta 100	265 €	391 €	472 €
hasta 130	299 €	426 €	506 €
hasta 160	334 €	460 €	541 €
LATERAL FIJO			
hasta 90	150 €	224 €	270 €

MERCURIO ALTURA 185 cm



MEDIDA	ACRÍLICO	TRANSP.	SERIGRAFÍA
hasta 90x90	265 €	395 €	500 €
hasta 100x80	286 €	415 €	521 €
hasta 125x80	349 €	477 €	583 €
hasta 140x80	391 €	529 €	605 €

URANO ALTURA 185 cm



MEDIDA	ACRÍLICO	CRISTAL	SERIGRAFÍA
75cm	365 €	505 €	600 €
80cm	370 €	510 €	605 €
90cm	380 €	520 €	615 €

Madera nogal incrementa 35%

SELENE ALTURA 185 cm



MEDIDA	ACRÍLICO	CRISTAL	SERIGRAFÍA
hasta 84cm	280 €	360 €	430 €
hasta 90cm	280 €	N/D	N/D

Medidas superiores en alto o ancho en Acrilico
+25,00 € cada 10 cm.

Medidas superiores en alto o ancho en Cristal
+30,00 € cada 10 cm.

Para bañera descuento 5%. Plata brillo incrementa 30%

COTAS MOLDE

LARGO

80 90 100 120 140 150 160 170 180 190 200 220

ANCHO

70 75 80 90 100 120

SERIE

MARCO NATURE



MARCO 4,5/5 cm.

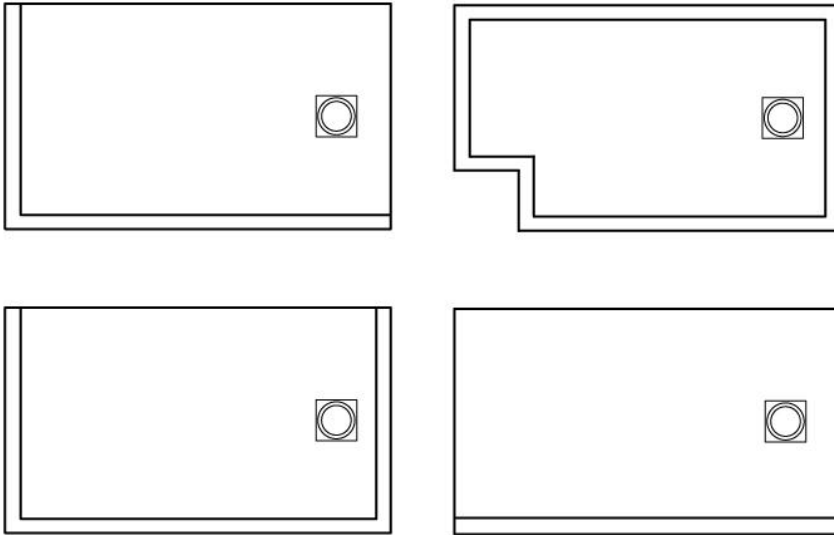

Datos expresados en EUROS

Válvula y rejilla incluidas en el precio

Color standard: Blanco, Grafito, Beige, Gris,

Para corte se tarifa la medida superior, cortes especiales 40 euros

Kit de reparación 30 euros

* Detalle técnico en la sección Nature

* Ver pesos en la sección Nature

MEDIDAS	80	90	100	120	140	150	160	170	180	190	200	220
70	348	348	348	403	440	469	486	518	545	579	599	742
80	377	377	377	446	488	500	522	567	589	631	659	800
90		377	407	474	508	518	533	614	643	715	748	835
100			437	509	565	589	613	695	735	763	793	935
120			509	604	691	731	788	830	872	908	982	1.092



COMPOSICIÓN

Resina de poliéster y cargas de última generación.

FUNDA EXTERIOR

Gel Coat antideslizante de Alta Resistencia.

TEXTURA

Pizarra natural Clase C3.



RAL cargo de 45 euros



COTAS MOLDE

LARGO

100 120 140 160 180 200

ANCHO

80 90

SERIE NATURE PLUS

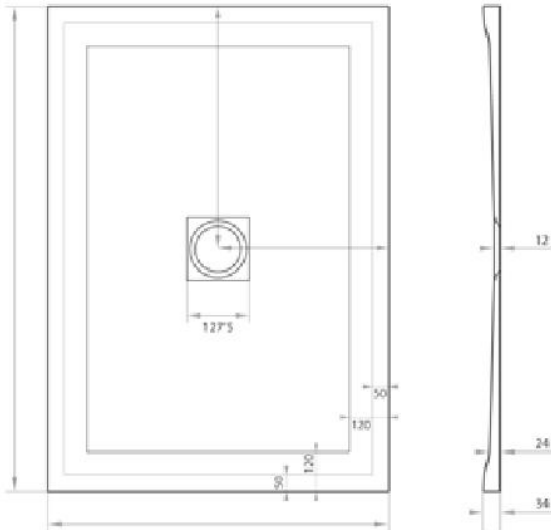

COTAS DESAGÜE A

VALVULAS CENTRALES EN TODAS LAS MEDIDAS

Ancho 80 90

Grueso 3,4 cm



Medidas	PESO
100	30 kg
120	36 kg
140	42 kg
160	48 kg
180	53 kg
200	59 kg

Ancho 80

Medidas	PESO
100	34 kg
120	41 kg
140	47 kg
160	54 kg
180	60 kg
200	66 kg

Ancho 90

MEDIDAS	80	100	120	140	160	180	200
80	263	294	306	340	371	402	433
90		325	340	371	402	449	479

Datos expresados en EUROS

Válvula y rejilla incluidas en el precio
Plazo de entrega semanal en color blanco,
otros colores consultar
Color standard: Blanco, Grafito, Beige, Gris,

Para corte se tarifa la medida superior,
cortes especiales 40 euros
Kit de reparación 30 euros



COMPOSICIÓN

Resina de poliéster y cargas de última generación.

FUNDA EXTERIOR

Gel Coat antideslizante de Alta Resistencia.

TEXTURA

Pizarra natural Clase C3.



RAL cargo de 45 euros



COTAS MOLDE

LARGO

100 120 140 150 160 170 180 200

ANCHO

70 80 90

SERIE PREMIUM

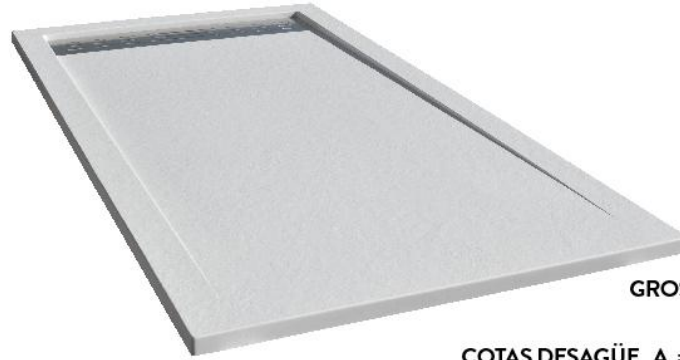
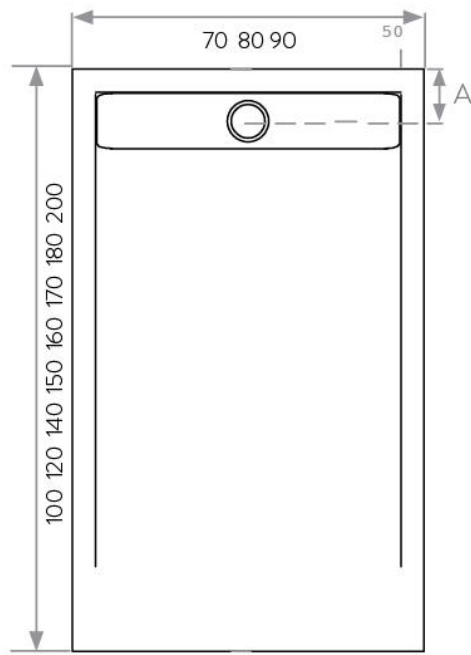

GROSOR B = 30 mm

COTAS DESAGÜE A = 120 mm 70/80

COTAS DESAGÜE A = 140 mm 90

Medidas	PESO
100	23 kg
120	27 kg
140	31 kg
150	35 kg
160	37 kg
170	40 kg
180	42 kg
190	47 kg
200	49 kg

Ancho **70**

Medidas	PESO
100	26 kg
120	31 kg
140	36 kg
150	40 kg
160	43 kg
170	45 kg
180	48 kg
190	53 kg
200	55 kg

Ancho **80**

Medidas	PESO
100	29 kg
120	34 kg
140	38 kg
150	45 kg
160	47 kg
170	50 kg
180	53 kg
190	59 kg
200	61 kg

Ancho **90**

MEDIDAS	100	120	140	150	160	170	180	200
70	309	341	357	378	395	414	431	466
80	328	353	370	386	404	424	441	487
90	343	389	424	457	465	510	530	585

Datos expresados en EUROS

Válvula y rejilla incluidas en el precio
 Plazo de entrega semanal en color blanco, otros colores consultar
 Color standard: Blanco, Grafito, Beige, Gris,
 Para corte se tarifa la medida superior, cortes especiales 40 euros
 Kit de reparación 30 euros



COMPOSICIÓN

Resina de poliéster y cargas de última generación.

FUNDA EXTERIOR

Gel Coat antideslizante de Alta Resistencia.

TEXTURA

Pizarra natural Clase C3.

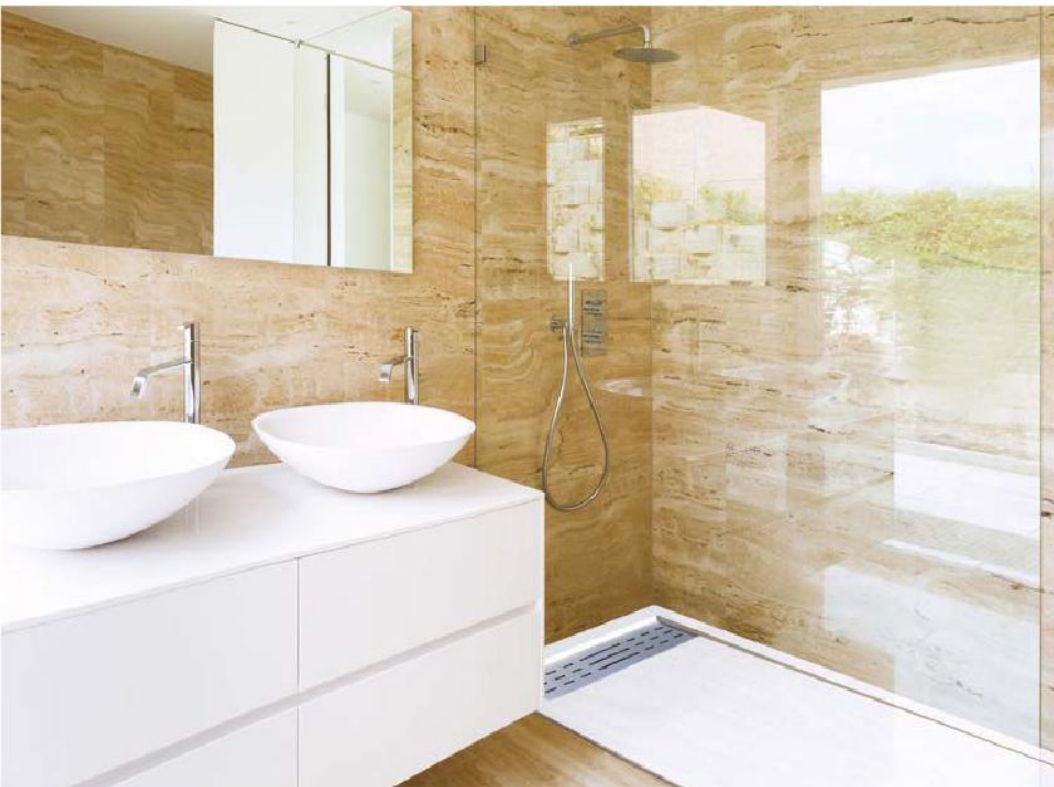

RAL cargo de 45 euros



COTAS MOLDE

LARGO
100 120 140 160 180 200

ANCHO
80 90

SERIE NEO

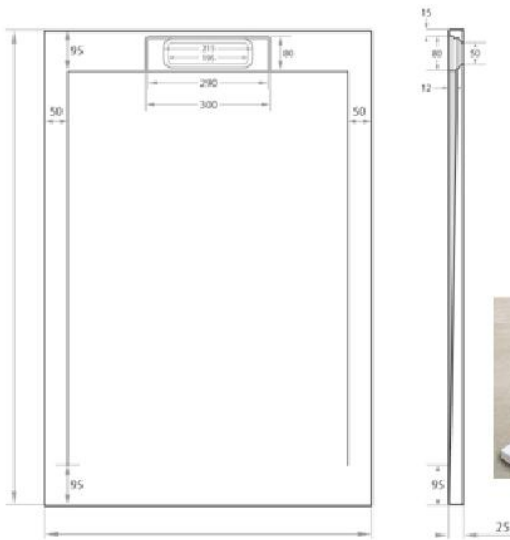

VÁLVULA MODELO NEO



Ancho **80**

Medidas	PESO
100	26 kg
120	31 kg
140	40 kg
160	45 kg
180 - 200	55 kg

Ancho **90**

Medidas	PESO
100	29 kg
120	34 kg
140	45 kg
160	50 kg
180-200	61 kg

MEDIDAS	100	120	140	160	180	200
80	328	353	370	404	441	487
90	343	389	424	465	530	585

Datos expresados en EUROS

Válvula y rejilla incluidas en el precio
Plazo de entrega semanal en color blanco,
otros colores consultar
Color standard: Blanco, Grafito, Beige, Gris,
Para corte se tarifa la medida superior,
cortes especiales 40 euros
Kit de reparación 30 euros



COMPOSICIÓN

Resina de poliéster y cargas de última generación.

FUNDA EXTERIOR

Gel Coat antideslizante de Alta Resistencia.

TEXTURA

Pizarra natural Clase C3.



RAL cargo de 45 euros



COTAS MOLDE

LARGO

70 80 100 120 140 160 180 200 220

ANCHO

60 70 80 90 100 120

SERIE

DECORATIVE

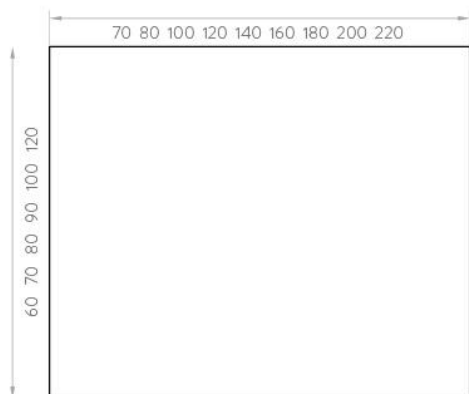

Los paneles de sustitución de 1 cm. de grosor se presentan como la solución idónea para sustituir una bañera por un plato de ducha sin necesidad de obra.

El acabado y textura es igual al del plato de ducha con sus mismos colores.

El panel se puede cortar si hay necesidad de un ajuste a medida al colocarlo.

MEDIDAS	70	80	100	120	140	160	180	200	220
60	96	104	124	150	162	182	200	219	237
70	107	119	139	162	185	208	228	251	274
80	119	130	156	182	208	231	257	284	312
90	130	150	173	200	228	257	286	315	347
100	139	156	188	219	250	284	315	347	378
120	161	180	219	257	296	332	376	411	447

Color standard: Blanco, Grafito, Beige, Gris, otros colores carta RAL cargo de 45 euros
Para corte se tarifa la medida superior, cortes especiales 40 euros

Kit de reparación 30 euros



COTAS MOLDE

LARGO

80 90 100 120 140 150 160 170 180 190 200 220

ANCHO

70 75 80 90 100 120

SERIE NATURE

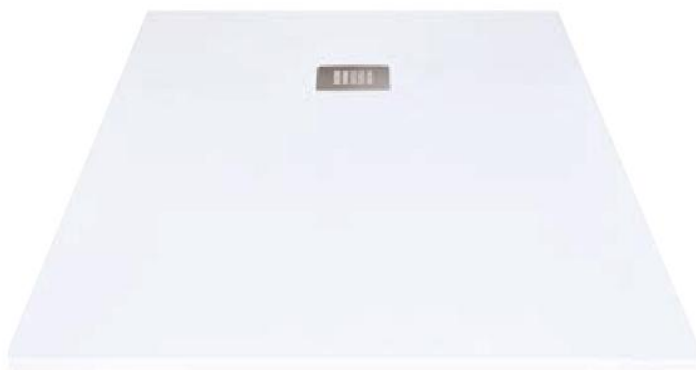
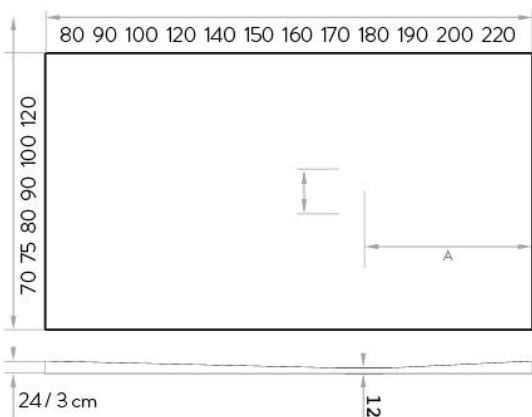

COTAS DESAGÜE A

80	*solo ancho 80	Central	23 kg
90 - 100	30 cm		23/26 kg
120	35 cm		28/31 kg
140 - 150	40 cm		33/45 kg
160 - 170	45 cm		40/49 kg
180 - 190 - 200	50 cm		43/61 kg
220	Central		58/66 kg

Ancho **70/75/80** Grueso **2,4/3 cm**

COTAS DESAGÜE A

90	30 cm	29/32 kg	
100	*ancho 100	Central	35/38 kg
120	35 cm	42/53 kg	
140 - 150	40 cm	51/60 kg	
160 - 170	45 cm	56/74 kg	
180 - 190 - 200	50 cm	74/82 kg	
220	Central		

Ancho **90/100** Grueso **2,4/3 cm**

COTAS DESAGÜE A

120	Central	46 kg
160	Central	68 kg
220	Central	98 kg

Ancho **120** Grueso **2,6/3 cm**

MEDIDAS	80	90	100	110	120	130	140	150	160	170	180	190	200	220
70	227	227	227	246	265	290	305	315	329	350	372	392	425	460
75	254	254	254	272	298	322	343	354	366	388	409	432	475	495
80	254	254	254	272	298	322	343	354	366	388	409	432	475	495
90		280	280	340	340	360	360	385	410	450	485	505	530	546
100			300	365	365	420	420	445	470	490	500	535	575	609
120			331	394	394	452	452	478	515	541	567	593	641	714



Datos expresados en EUROS

Válvula y rejilla incluidas en el precio

Color standard: Blanco, Grafito, Beige, Gris,
otros colores carta RAL cargo de 45 euros
Para corte se tarifa la medida superior, cortes
especiales 40 euros

Kit de reparación 30 euros





BAÑOS DEL DUERO

LOS PRECIOS DE ESTE CATALOGO NO INCLUYEN :
IVA, TRANSPORTE Y MONTAJE
PORTES PAGADOS +250 € PVP
INFERIOR A 250 € INCREMENTO DE 10 € POR ENVIO

bduero@bduero.es
983 310 134